

ZAHNÄRZTLICHE HAND- INSTRUMENTE

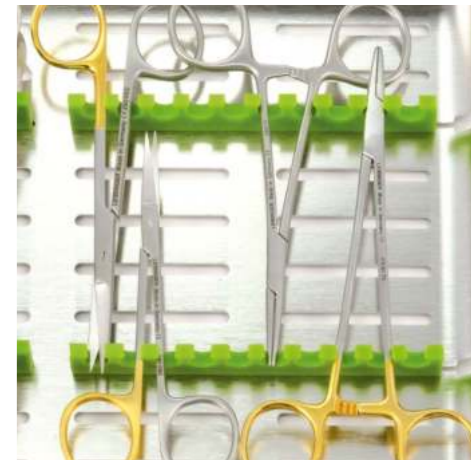

FLOTT BESTELLEN:
Kontaktaufnahme per Telefon, Mail und Webshop

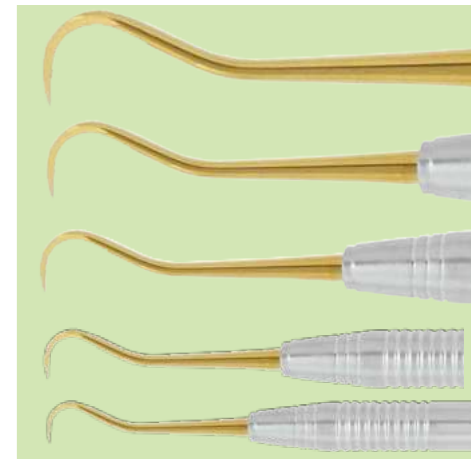
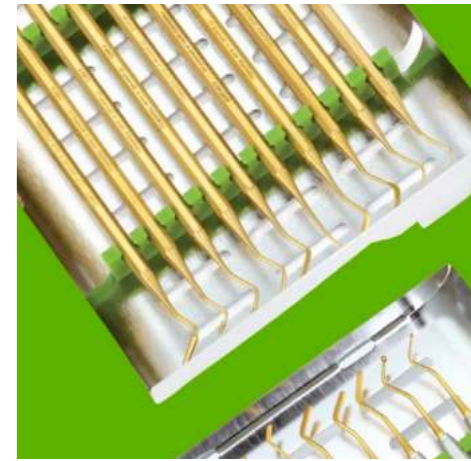

Birkenweg 3 • 21376 Salzhausen
Tel.: 04172-98 78 -00 • Fax: 04172-98 78-012
E-Mail: info@voss-dental.de • Web: voss-dental.de
WhatsApp: 01522-809 11 11



PRODUKTKATALOG
in vertrauensvoller
Zusammenarbeit mit der Firma
Leibinger aus Mühlheim / Germany

WAS SIE WISSEN SOLLTEN:

Die meisten zahnärztlichen Instrumente werden aus korrosionsbeständigen Edelstählen gefertigt. Die Anforderungen an die verschiedenen Stahlsorten sind in nationalen und internationalen Normen festgelegt und auf die besonderen funktionellen Eigenschaften und Einsatzbedingungen abgestimmt. Für nicht schneidende Instrumente, beispielsweise Zahnzangen oder Pinzetten, werden gute Elastizität, Zähigkeit und hohe Korrosionsbeständigkeit gefordert. Schneidende Instrumente wie Zahnreiniger, Scheren oder Messer verlangen vor allem hohe Härte sowie Beständigkeit gegen Verschleiß und Korrosion.

Fragt man nach der Bedeutung von Begriffen wie Edelstahl, nicht rostender Stahl, stainless steel, so wird häufig vermutet, dass Edelstahl ein unverwüstliches, äußerst beständiges Material sei. Zahlreiche Benutzer sind überrascht, wenn sie erfahren oder selbst feststellen müssen, dass auch Edelstahl durchaus gegen die vielfältigen Angriffe mechanischer, thermischer oder chemischer Art anfällig sein kann. Die Korrosionsbeständigkeit der Edelstähle beruht darauf, dass sie aufgrund ihrer Legierung so genannte Passivschichten an der Oberfläche bilden, die den Stahl schützen.

Durch äußere Einflüsse können diese Schutzschichten jedoch zerstört werden, und es entstehen dann Schäden an den Instrumenten. Es ist deshalb außerordentlich wichtig, durch sachkundige Aufbereitung die Passivschichten der Instrumente zu erhalten.

Detaillierte und umfangreiche Informationen zur Instrumentenaufbereitung erhalten Sie in der aktuellen Broschüre „Instrumentenaufbereitung in der Zahnarztpraxis richtig gemacht“, als kostenloser Download auf www.a-k-i.org.



Birkenweg 3 · 21376 Salzhausen
 Tel.: 04172 - 98 78 - 00
 Fax: 04172 - 98 78 - 012
 E-Mail: info@voss-dental.de
 Web: voss-dental.de
 WhatsApp: 01522 - 809 11 11

WAS SIE WISSEN SOLLTEN	2
Zahnsonden	4-5
Sonden & Spiegel	6
Griffe	7
Parodontalsonden	8-9
Pinzetten	10
Füllungsinstrumente	11-14
Exkavatoren	15-17
Compofill-Instrumente	18-19
Compofill Set	19
Spatel	20
Modellier-Instrumente	21
Matrizenspanner	22
Tamponstopfer	22
Kofferdamm Instrumente	23-26
Kofferdamm Set	23
Kofferdamm Klammern	24-25
Kofferdamm Instrumente	26
Endodontie Pinzetten	27
Stopfer / Spreizer	28
Paro Sets	29
Endo / Paro Set	29
SParo Classic Set	30
Küretten / Scaler	31
Colorident Küretten (mit Farbring)	31
Colorident Küretten & Scaler (mit Farbring)	32
Gracey Küretten	33
Gracey Küretten Mini	34
Sichel Scaler	35
Universal Scaler / Universal Küretten	36-37
Sharp Cut Gracey und Scaler	38-39
Gingivektomie Messer	40
Paro-Feilen	41
Tunnelier-Instrumente	42
Raspatorien	43+72
Titan Küretten	44
Zangen Otto Leibinger	45-58
Englische Form	46-54
Zangen Kinder	52-53
Zangen Kinder Kurz	53-54
Zahnzangen Extraktions-Set	55
Deep Grip Spezialzangen	56-57
Wurzelsplitter-Zangen	58
Wurzelheber	59-63
Luxatoren	64-65
Spritzen	66
Mundhaken / Zungenspatel	67-70
Hammer	71
Feilen / Scharfe Löffel	73
Scalpellgriffe	74
Saugkanüle / Pinzetten	75-78
Anatomische Pinzetten	75-76
Chirurgische Pinzetten	77-78
Scheren	79-81
Nadelhalter	82-84
Chirurgie Basis Set	85
Arterienklemmen	86-87
Hohlmeisselzangen	88-89
Titaninstrumente	90
Kronenabnehme-Zange	91



Sondermodelle
auf Anfrage
ab 20 Stück

Ø8mm
hollow, light
hohl, extra leicht

100/... 101/... 102/... 103/... 122/...-ED **ERGODESIGN**

ZAHNSONDEN



ED = mit
ERGODESIGN-
Griff

Mit feinen
flexiblen Spitzen
federhart

105/... 107/... 123/...-ED **ERGODESIGN**

Ø8mm
hollow, light
hohl, extra leicht

ZAHNSONDEN & SPIEGEL

GRIFFE FÜR ZAHNSONDEN & SPIEGEL



Fig.8 104/8 | Fig.9 104/9 | Fig.11 104/11 | Fig.17 104/17 | Fig.23 104/23

Sondenspitzen mit Gewinde

Alle Einsätze
passend zu
den Griffen
von Seite 6

MIKROSPIEGEL FS RHODIUM



Ø3mm 201/10 | Ø5mm 201/20 | 3x6mm 201/30



plan 200/08 | hohl 200/06



200/8 | 200/6

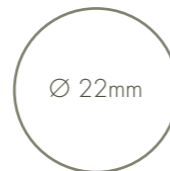

200/12 | 200/11

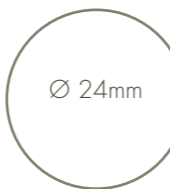

12 STÜCK PRO EINHEIT

Alle Spiegel mit
„Front Surface“
erhältlich.
Bitte ergänzen Sie die
Artikelnummer mit
„FS“.



hohl, verchromt
200/1



hohl, rostfrei
200/2



hohl, rostfrei
200/3



hohl, rostfrei
200/4



massiv, rostfrei
200/5



ERGODESIGN
200/51



ENDO-SPECIAL
ENDODONTIE-SPEZIAL
ERGODESIGN mit Messkala am Griff (0-30mm)
200/51M

Passende Griffe
für Sonden
und Spiegel
von Seite 5

FURKATIONS-SONDE

2-3-5-7-8-9-10
1-2-3-5-7-8-9-10
flach



WILLIAMS 23W 405/23W	GOLDMAN-FOX-WILLIAMS 405/PGFW
ohne Farbmarkierungen	ohne Farbmarkierungen

NABERS 2N 405/2N	NABERS 2N 405/2NCV
	farbcodiert

PARODONTALSONDEN



1-2-3-5-7-8-9-10



WILLIAMS
ohne Farbmarkierungen
405/W
405/W-ED

1-2-3-5-7-8-9-10



CP10
405/CP10

1-2-3-5-7-8-9-10
flat flach



GOLDMAN-FOX PGF
405/PGF

3-6-8-11



CP11
405/CP11

3-6-9-12



CP12
405/CP12
405/CP12-ED

2-4-6-8-10-12



NEU CP22N
405/CP22N
405/CP22N-ED

1-2-3-4-5-6-7-8-9
10-11-12-13-14-15



CP15
405/CP15
405/CP15-ED

3,5,5,8,5-11,5



WHO
405/WHO
405/WHO-ED

3,5,5,8,5-11,5



WHO
405/WHO-ED

mit TiN Beschichtung
für die Verwendung
an Implantaten

Spezielle
biokompatible
Farbbeschichtung



LONDON COLLEGE
180/5

LONDON COLLEGE
diamantiert
180/5D

LONDON COLLEGE
mit Schloss
180/6

LONDON COLLEGE
glatter Griff
180/10

Endo-Pinzette
mit Schloss
15cm
180/68



MILLER
Artikulationspapier
Pinzette
180/1

PERRY
180/8

MERIAM
180/9

Nahtpinzette
15cm
181/4



UNSERE 3 HANDGRIFFE

1 Achtkant-Griff
Ø 5,5mm

2 Rundgriff massiv
Ø 6mm

3 ERGODESIGN
Ø 8mm

ERGODESIGN GRIFF

- Ergonomische Form für komfortables und ermüdungsfreies Arbeiten
- Ø 8mm, extra leicht
- Sicherer Grip auch beim Arbeiten mit Handschuhen und feuchten Händen durch die rutschhemmende Riffelung
- Formschönes und modernes Design
- Problemlose Reinigung

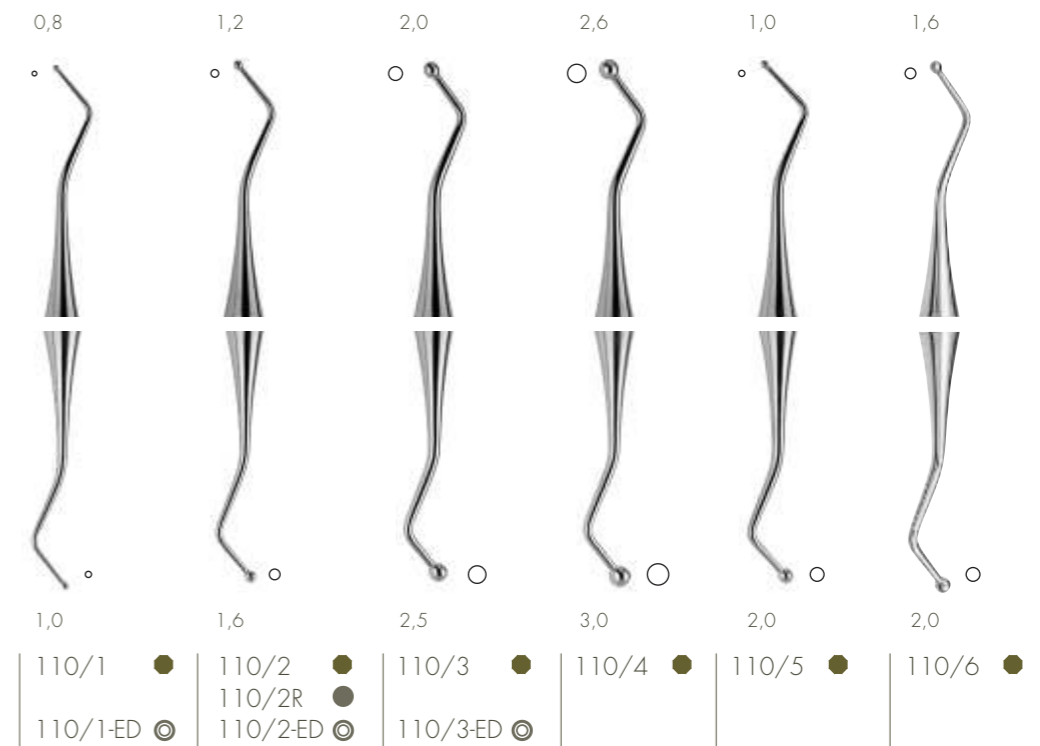

110/1 ●	110/2 ●	110/3 ●	110/4 ●	110/5 ●	110/6 ●
110/1-ED ⊙	110/2R ●	110/3-ED ⊙			
	110/2-ED ⊙				

FÜLLUNGSTRUMENTE

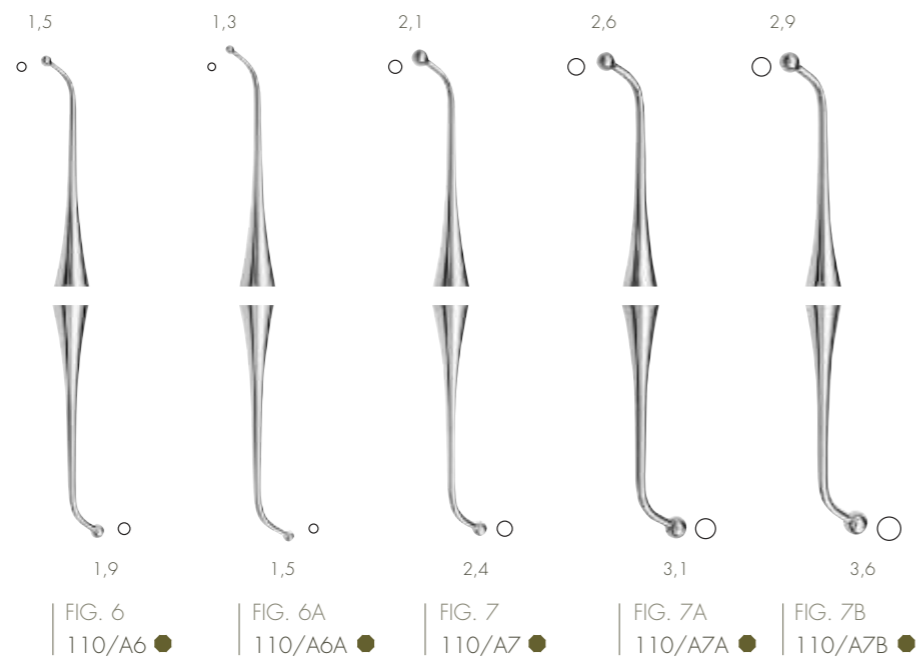
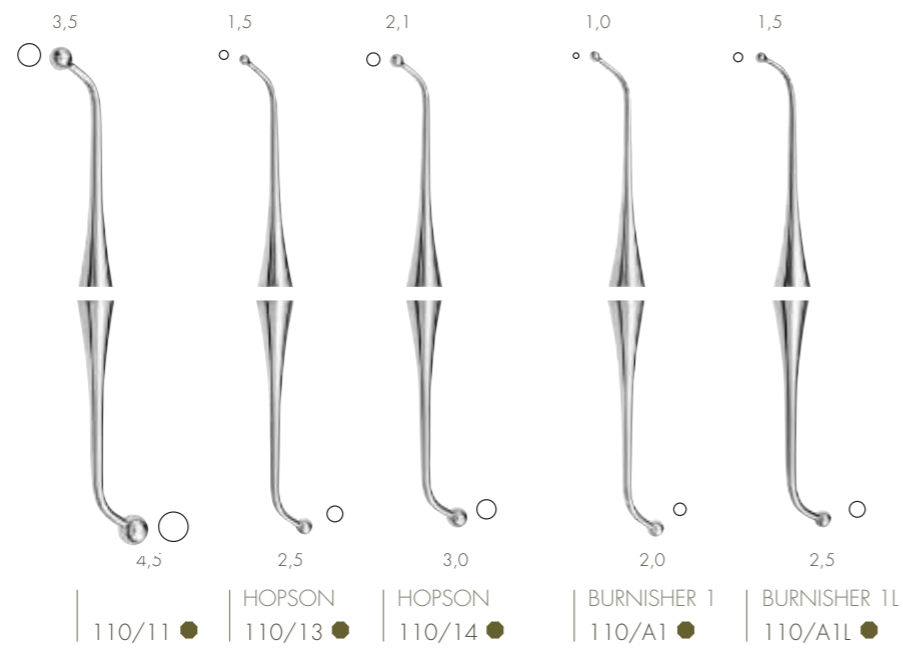
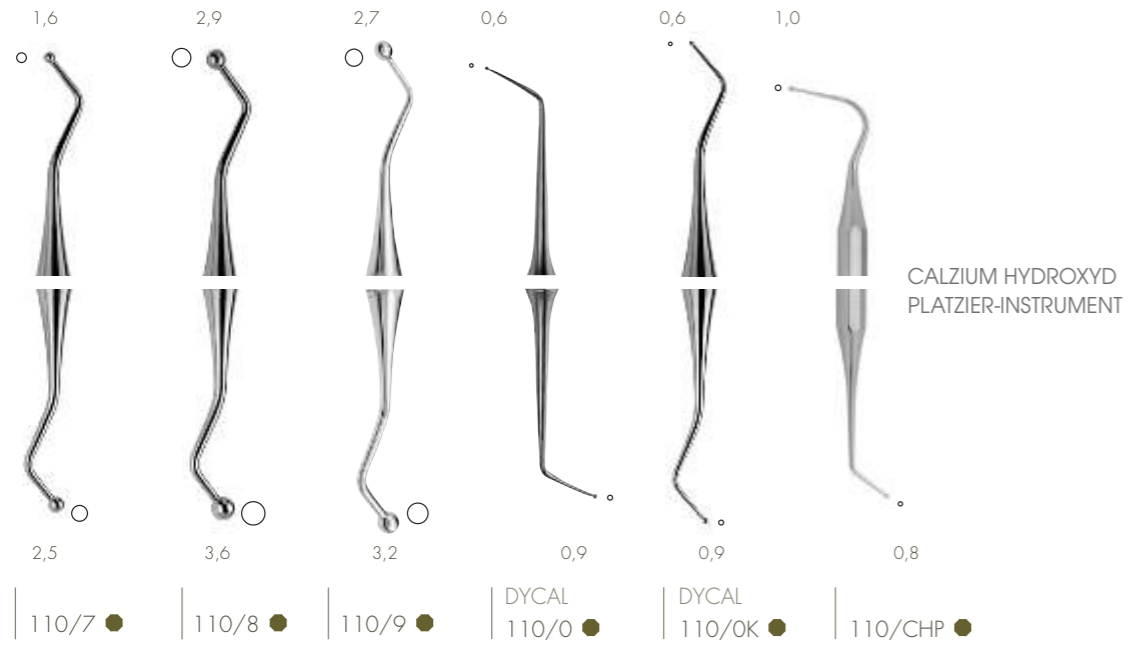

FÜLLUNGSTRUMENTE

KUGEL / SPATEL

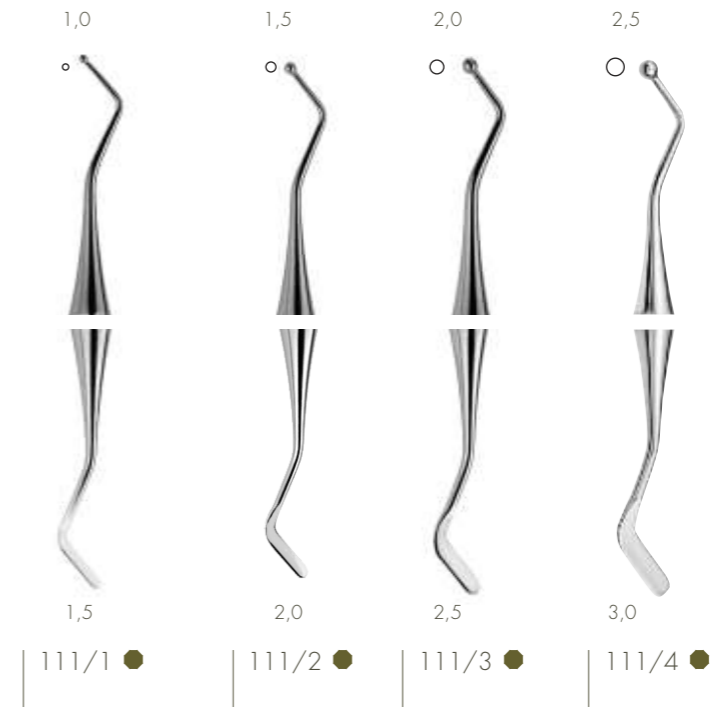

BIRNENFORM

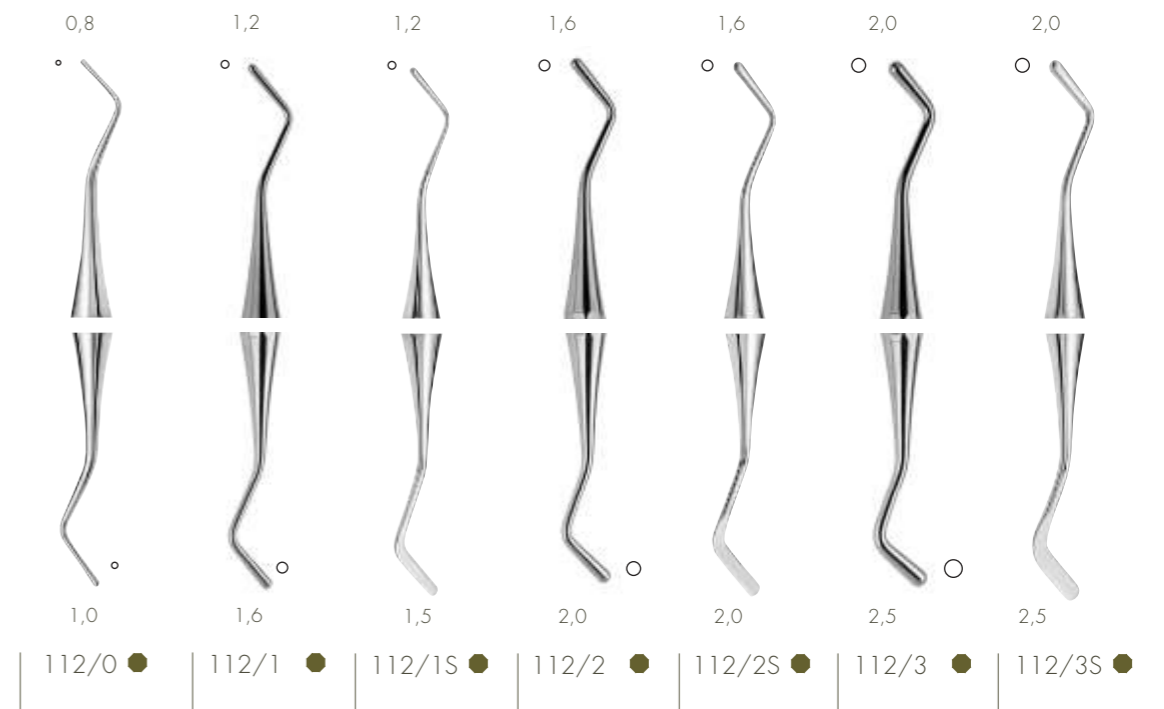

Achtkant-Griff
Ø 5,5mm

Rundgriff massiv
Ø 6mm

ERGODESIGN
Ø 8mm

UNSERE 3 HANDGRIFFE

SPATEL

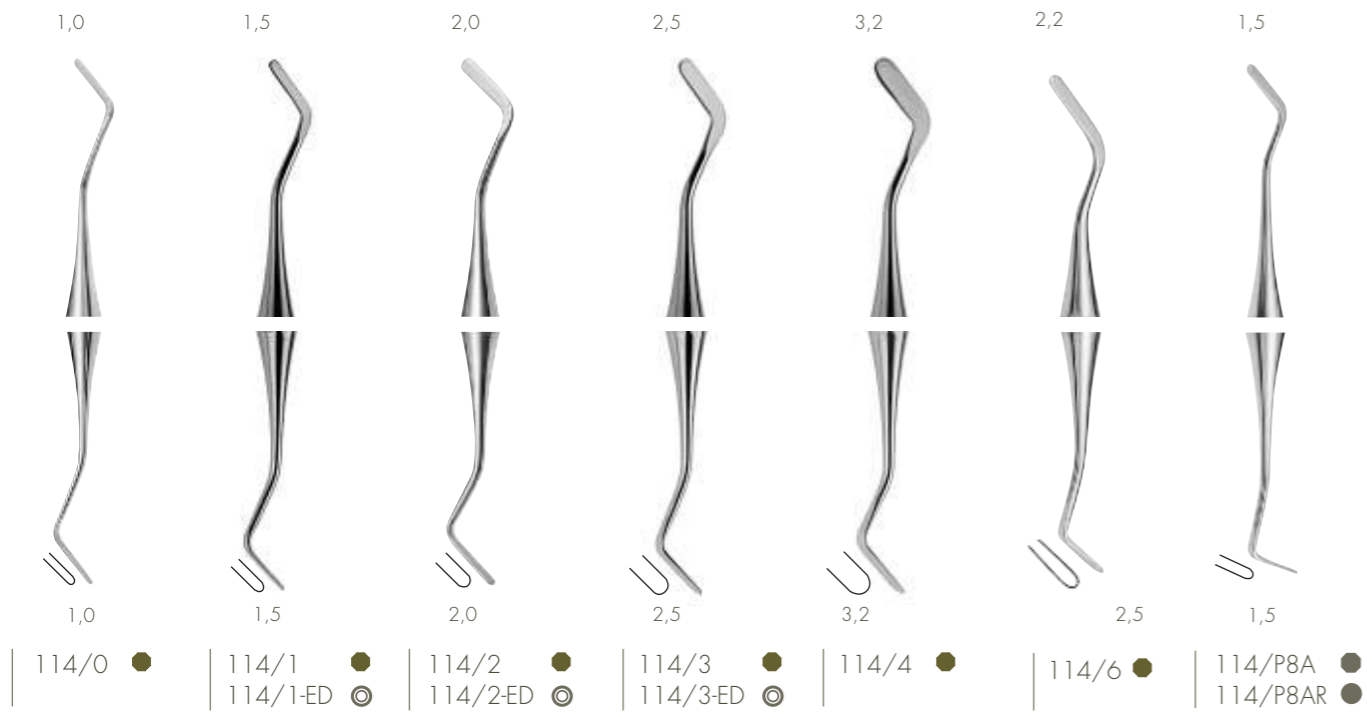

SPATEL – SPEZIALITÄTEN

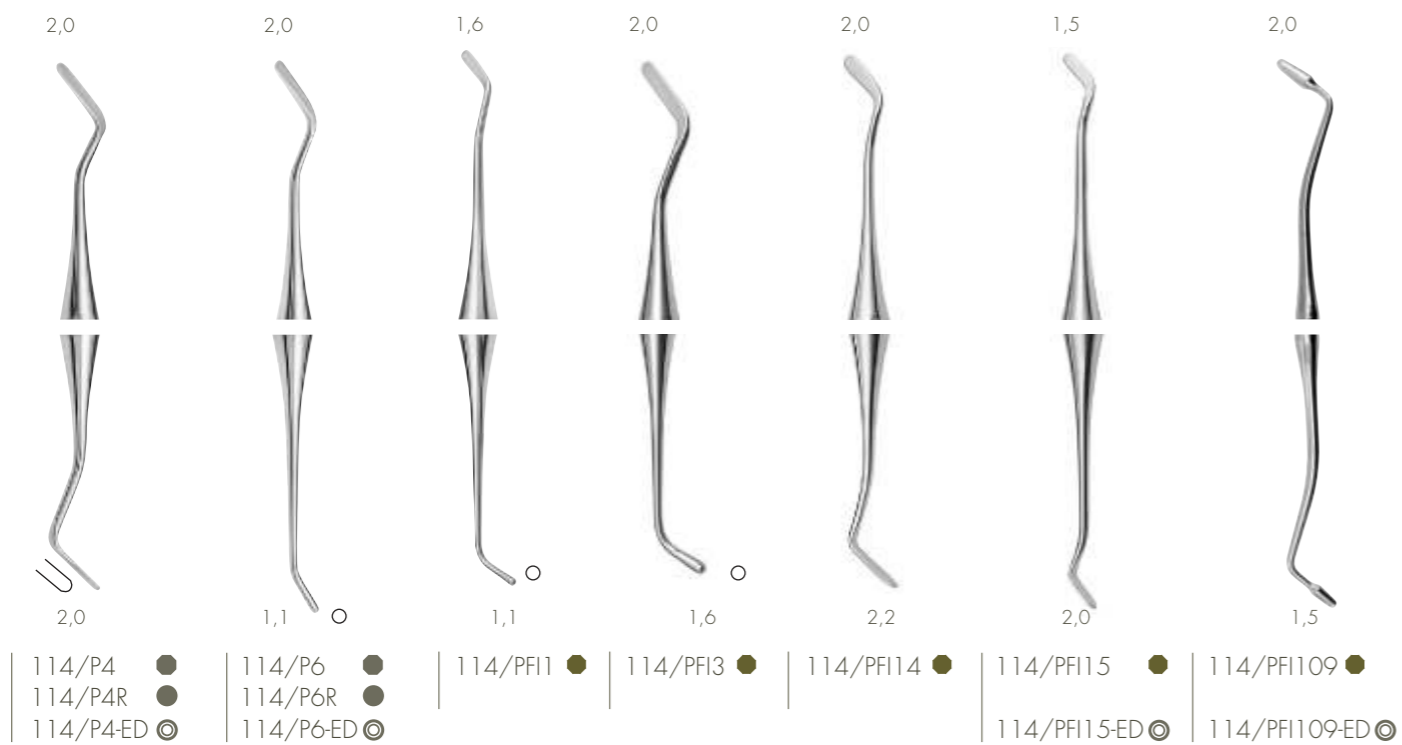

Achtkant-Griff
Ø 5,5mm

Rundgriff massiv
Ø 6mm

ERGODESIGN
Ø 8mm

UNSERE 3 HANDGRIFFE



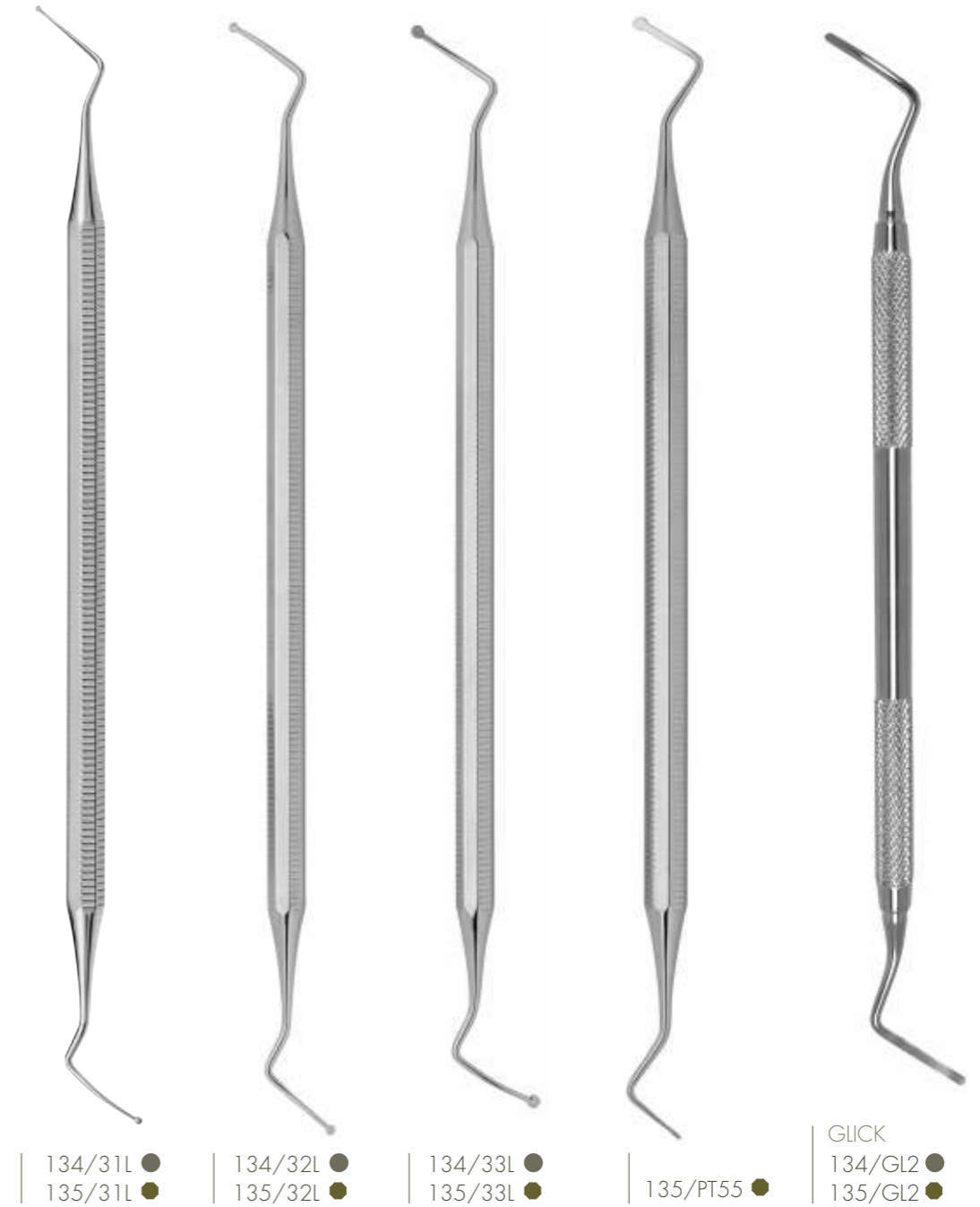







ENDO EXKAVATOREN

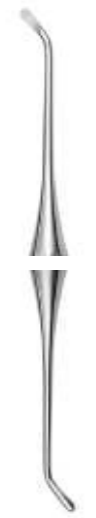

Achtkant-Griff
Ø 5,5mm

Rundgriff massiv
Ø 6mm

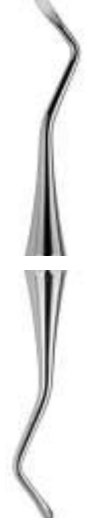









GRIFFVARIANTEN

	1,7	2,1	1,1	1,5	2,0
					
	134/14 ● 135/14 ●	DARBY-PERRY 220/221 134/15 ● 135/15 ●	134/S11 ● 135/S11 ●	134/S15 ● 135/S15 ●	134/S20 ● 135/S20 ●
	1,5	1,5	1,7	2,5	
					
	EXC 5 134/16 ● 135/16 ●	EXC 17 134/17 ● 135/17 ●	EXC 18 134/18 ● 135/18 ●	EXC 19 134/19 ● 135/19 ●	

 Achtkant-Griff
 Ø 5,5mm

 Rundgriff massiv
 Ø 6mm

GRIFFVARIANTEN

	1,1	1,3	2,1	1,7	1,5	1,6
						
	133/134 134/09 ● 135/09 ●	131/132 134/10 ● 135/10 ●	125/126 134/11 ● 135/11 ●	127/128 134/12 ● 135/12 ●	129/130 134/13 ● 135/13 ●	159/160 135/21 ●
	1,4	1,8	2,0			
						
	243 135/729 ●	244 135/730 ●	245 135/731 ●			

 Achtkant-Griff
 Ø 5,5mm

 Rundgriff massiv
 Ø 6mm

GRIFFVARIANTEN

COMPOFILL-INSTRUMENTE / ERGODESIGN

Unsere COMPO-FILL Instrumente haben eine spezielle hochglanzpolierte TiN (Titan-Nitrid) Beschichtung, die das Festkleben des Composites an den Arbeitsenden verhindert. Die Beschichtung ist sehr viel härter als Edelstahl und dadurch auch sehr resistent gegen die verschiedenen Reinigungs- und Sterilisationsprozesse.

ERGODESIGN
8mm, extra leicht,
rutschsichere
Griffenden

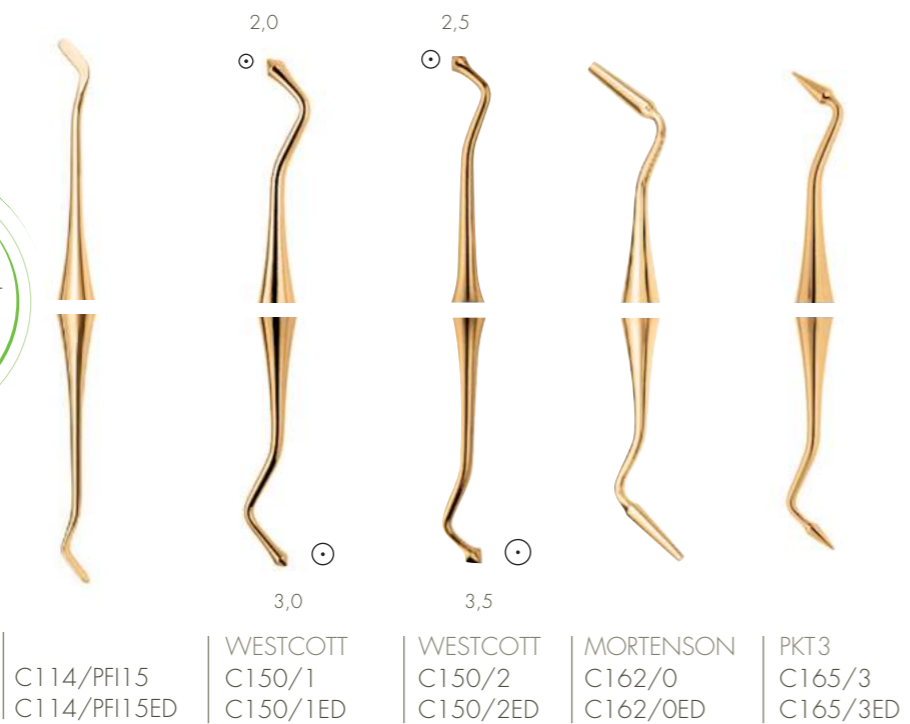
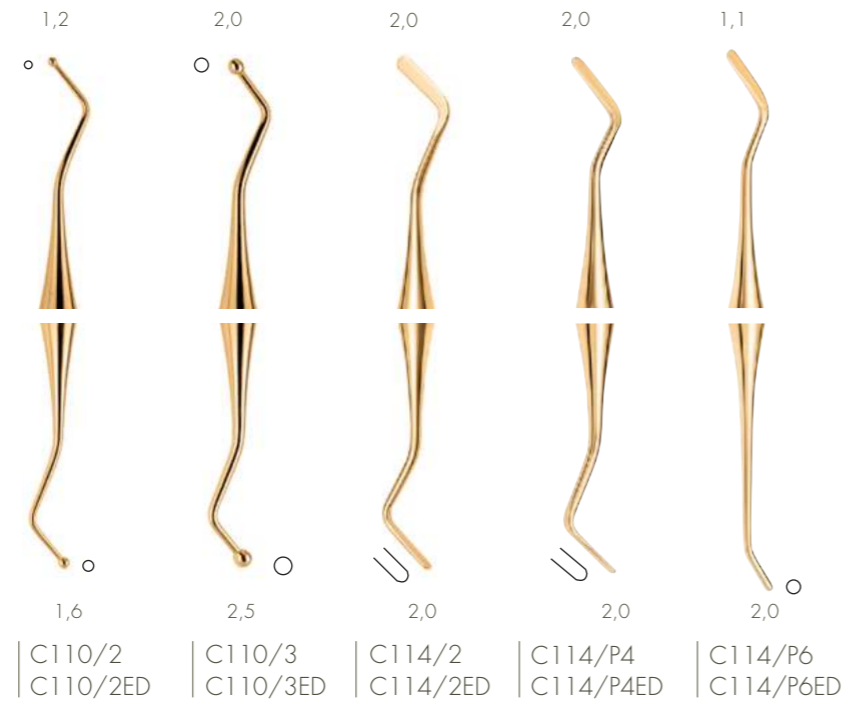

ED = mit
ERGODESIGN-
Griff

COMPOFILL-SET AUCH MIT ERGODESIGN-GRIFF ERHÄLTlich

C110/2	C110/2-ED	Compo-Fill Filling Instrument
C110/3	C110/3-ED	Compo-Fill Filling Instrument
C114/2	C114/2-ED	Compo-Fill Filling Instrument
C114/P4	C114/P4-ED	Compo-Fill Instrument No.4
C114/P6	C114/P6-ED	Compo-Fill Instrument No.6
C114/PFI15	C114/PFI15-ED	Plastic Filling Instrument No. 15
C150/1	C150/1-ED	Compo-Fill Finishing Instrument Westcott
C150/2	C150/2-ED	Compo-Fill Finishing Instrument Westcott
C162/0	C162/0-ED	Compo-Fill Filling Instrument Mortenson
C165/3	C165/3-ED	Compo-Fill Carving Instrument
500/T	500/T	Wash Tray with Silicon Inlay for storage of 10 instruments 184 x 150 x 25mm



ZEMENTSPATEL

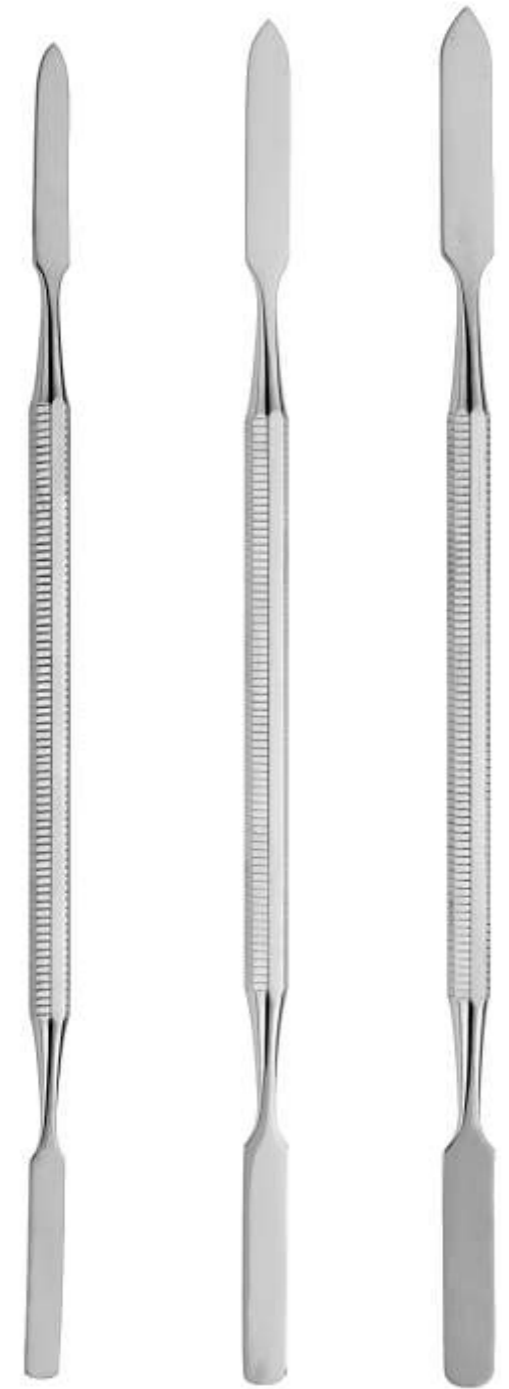

140/1 | 140/2 | 140/3

FLEXIBEL

HEIDEMANNSPATEL

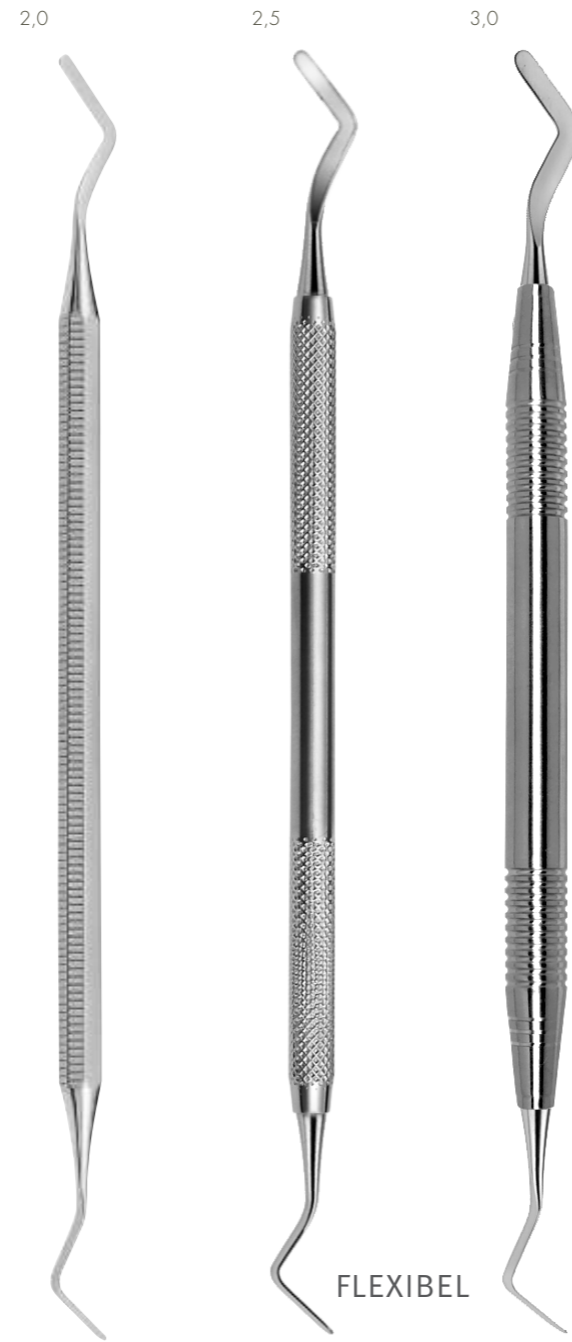

2,0 | 2,5 | 3,0

116/0 ●	116/1 ●	116/2 ●
116/OR ●	116/1R ●	116/2R ●
116/0-ED ⊙	116/1-ED ⊙	116/2-ED ⊙

Auch erhältlich als COMPO-FILL mit TiN Beschichtung

C116/0 ●	C116/1 ●	C116/2 ●
C116/0-ED ⊙	C116/1-ED ⊙	C116/2-ED ⊙



UNSERE 3 HANDGRIFFE

KONSERVIERENDE BEHANDLUNG

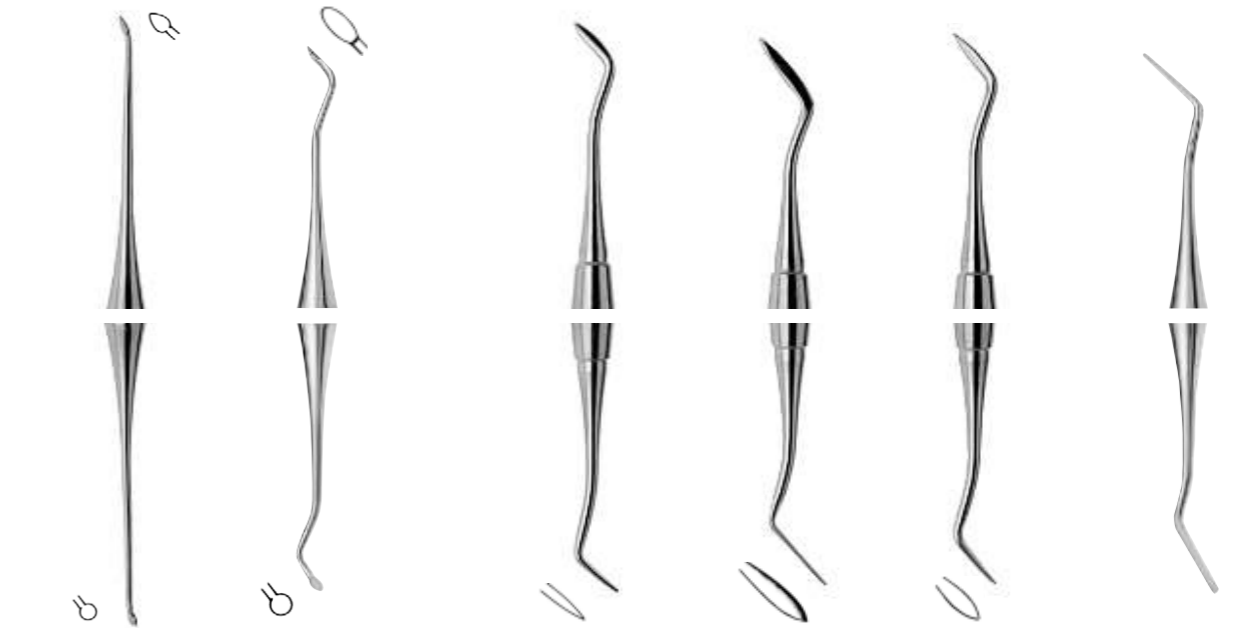

DISCOID CLEOID 89/92	DISCOID CLEOID 3/6	HOLLENBACK 1/2	HOLLENBACK 3	HOLLENBACK 3S	INTERPROXIMAL
160/1 ●	160/3-6 ●	160/H12 ●	160/H3 ●	160/H3S ●	160/J2 ●
162/1 ●	162/3-6 ●	161/H12 ●	161/H3 ●	161/H3S ●	162/J2 ●

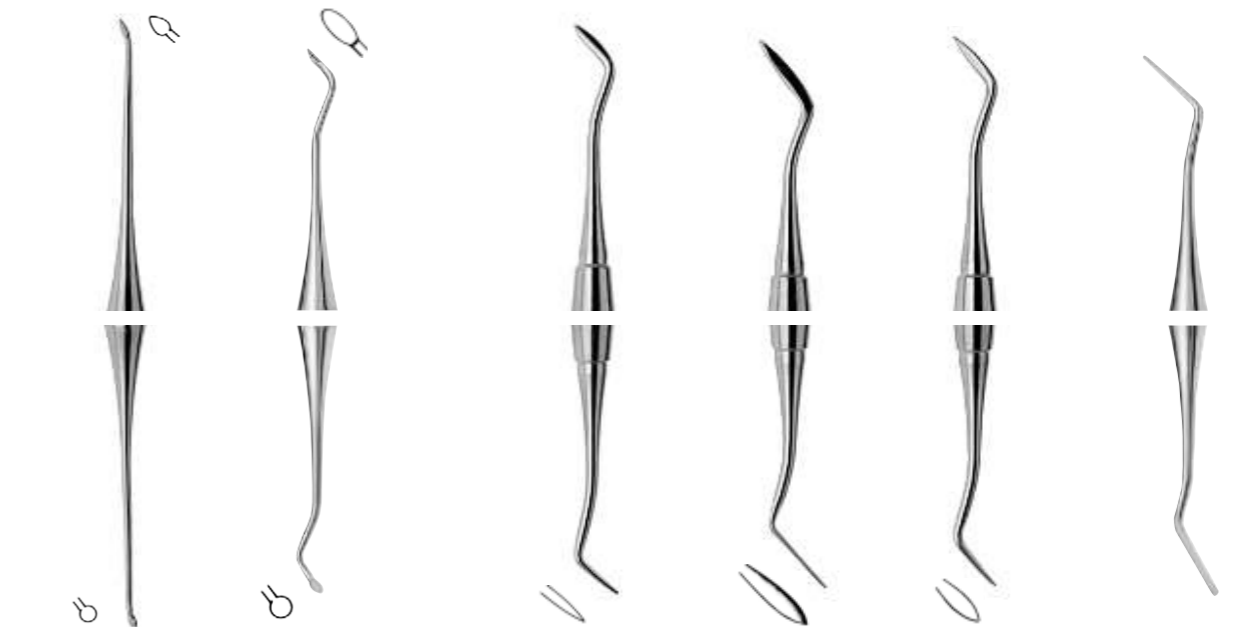

DISCOID CLEOID 89/92	DISCOID CLEOID 3/6	HOLLENBACK 1/2	HOLLENBACK 3	HOLLENBACK 3S	INTERPROXIMAL
160/1 ●	160/3-6 ●	160/H12 ●	160/H3 ●	160/H3S ●	160/J2 ●
162/1 ●	162/3-6 ●	161/H12 ●	161/H3 ●	161/H3S ●	162/J2 ●



GRIFFVARIANTEN

KONSERVIERENDE BEHANDLUNG



TOFFLEMIRE
Universal
320/1



TOFFLEMIRE
Junior
320/2



TOFFLEMIRE
Senior
320/3

TAMPONSTOPFER LUNIATSCHEK

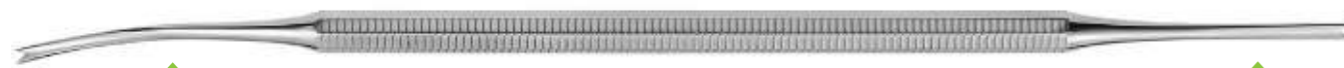

GEBOGEN ↑

LUNIATSCHEK
Tamponstopfer
117/1

GERADE ↑

ENDODONTIE KOFFERDAMM SET

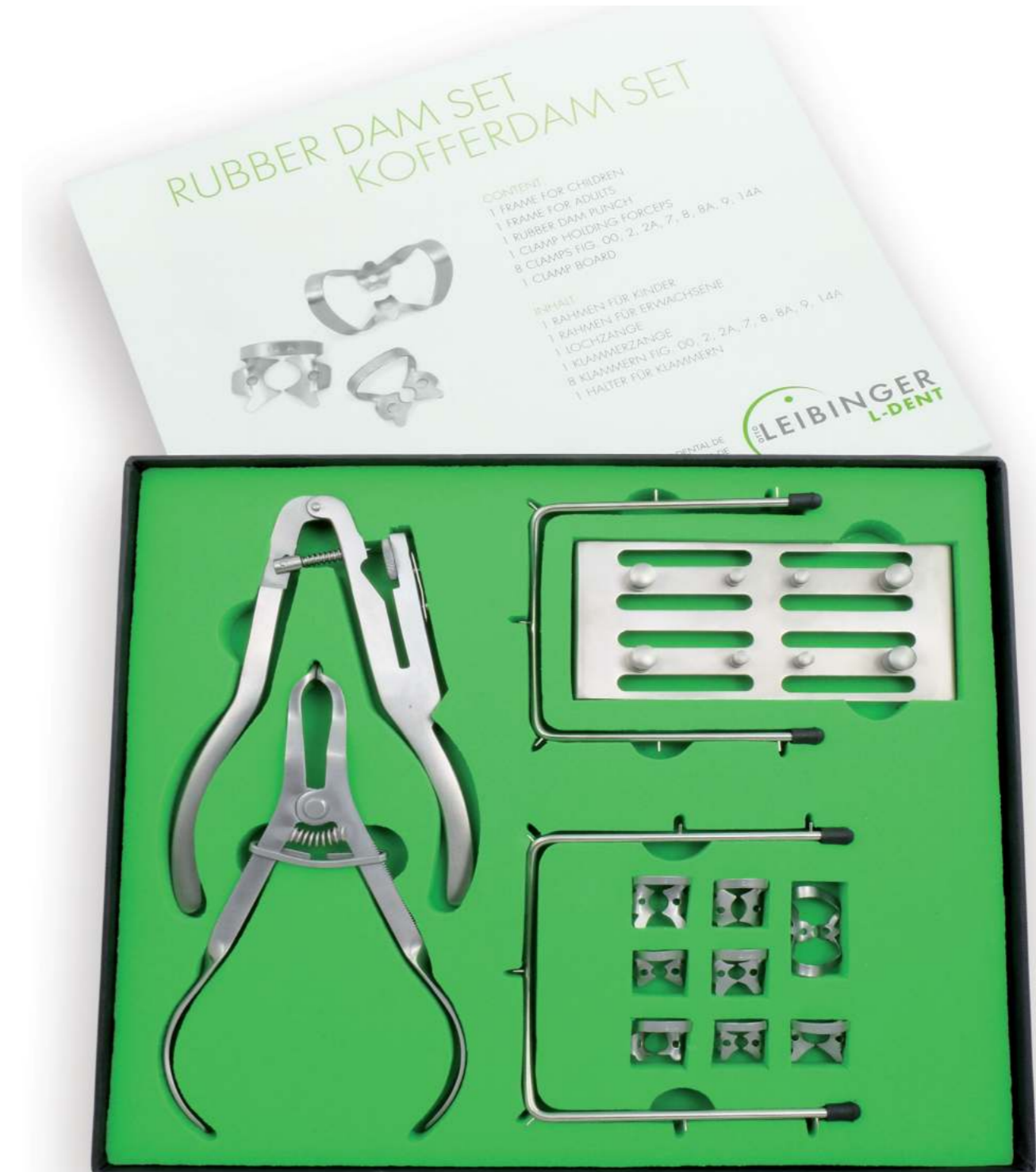

KOFFERDAMM SET

INHALT

- 1 Rahmen für Kinder
- 1 Rahmen für Erwachsene
- 1 Lochzange
- 1 Klammerzange
- 8 Klammern Fig. 00, 2, 2A, 7, 8, 8A, 9, 14A
- 1 Halter für Klammern

KOFFERDAMM KLAMMERN



316/RDC0
für obere und untere Prämolaren



316/RDC13A
für untere Molaren, links



316/RDC00
untere Eckzähne und Prämolaren



316/RDC14
für Molaren



316/RDC1
für obere Prämolaren



316/RDC14A
für große Molaren



316/RDC10
kleine Molaren links oben u.rechts unten



316/RDC15
für untere Molaren, groß



316/RDC10A
für obere und untere Molaren

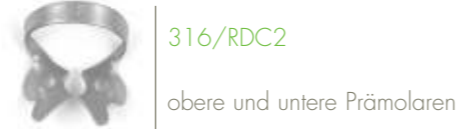

316/RDC2
obere und untere Prämolaren



316/RDC11
kleine Molaren links unten u.rechts oben



316/RDC200
große Klammern für untere Molaren



316/RDC12
für obere und untere Molaren



316/RDC201
für obere Molaren

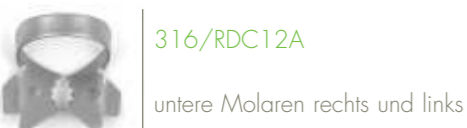

316/RDC12A
untere Molaren rechts und links

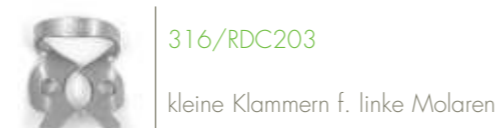

316/RDC203
kleine Klammern f. linke Molaren



316/RDC204
kleine Klammern f. rechte Molaren



316/RDC205
grosse Klammern für obere Molaren



316/RDC4
für kleine obere Molaren



316/RDC206
für untere Molaren



316/RDC5
grosse Klammern für obere Molaren



316/RDC212
für labiale Karies an Frontzähnen



316/RDC56
für große Molaren

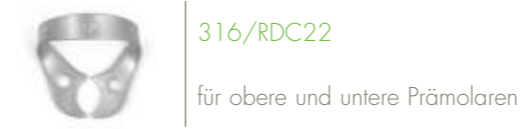

316/RDC22
für obere und untere Prämolaren



316/RDC7
für untere Molaren



316/RDC23
für obere und untere Molaren



316/RDC7A
für große untere Molaren



316/RDC26N
für obere Molaren



316/RDC8
grosse Klammern für obere Molaren



316/RDC2A
für obere und untere Prämolaren



316/RDC8A
für Wurzeln v. oberen u. unteren Molaren



316/RDC3
für untere Molaren



316/RDC9
für Frontzähne

316/00
Halterung ohne Klammern



316/01
Set mit 8 Kofferdamm Klammern inkl. Halterung
Fig.00 untere Eckzähne und Prämolaren
Fig.2 obere und untere Prämolaren
Fig.2A obere und untere Prämolaren
Fig.7 untere Molaren
Fig.8 obere Molaren
Fig.8A Wurzeln von oberen und unteren Molaren
Fig.9 Frontzähne
Fig.14A große Molaren



AINSWORTH, 17cm
Kofferdam-Lochzange
315/1



IVORY, 16cm
Kofferdam-Lochzange
315/2



STOKE, 17cm
Kofferdam-Klammerzange
315/3



IVORY, 17cm
Kofferdam-Klammerzange
315/4



BREWER, 17cm
Kofferdam-Klammerzange
315/5

ENDODONTIE PINZETTEN

Extrem
feine
Spitzen

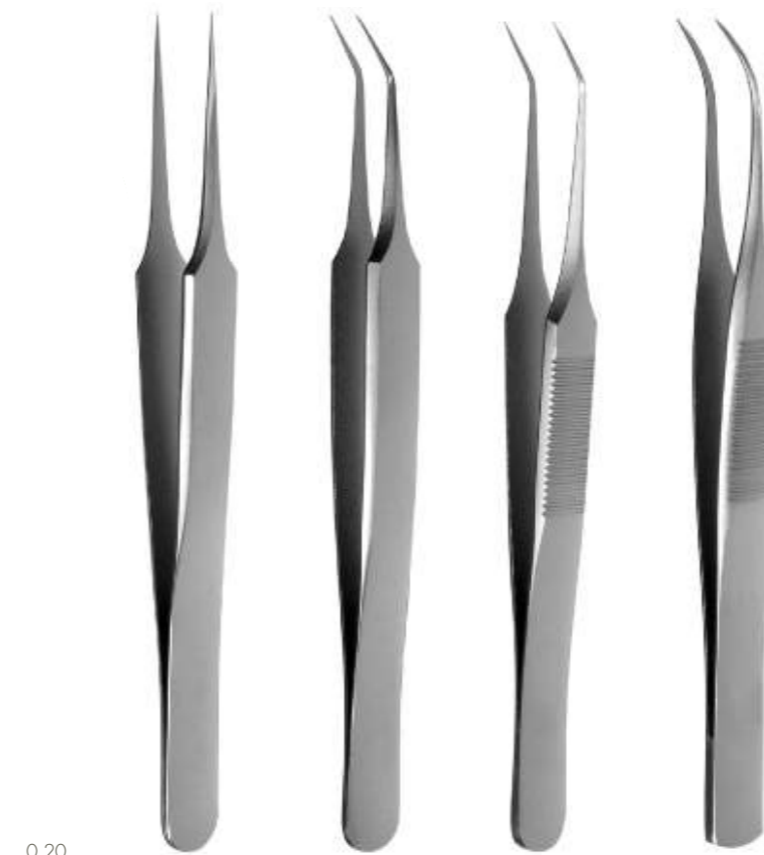

[110mm
184/41

[110mm
184/42

[110mm
184/43

[110mm
184/44



Spreizer
118/S20

0.30

0.40

0.50



118/S30

118/S40

118/S50



Wurzelkanalzange
610/5



Nahtpinzette
15cm
181/4



Endo-Pinzette
mit Schloss
15cm
180/68

ENDODONTIE STOPFER / SPREIZER

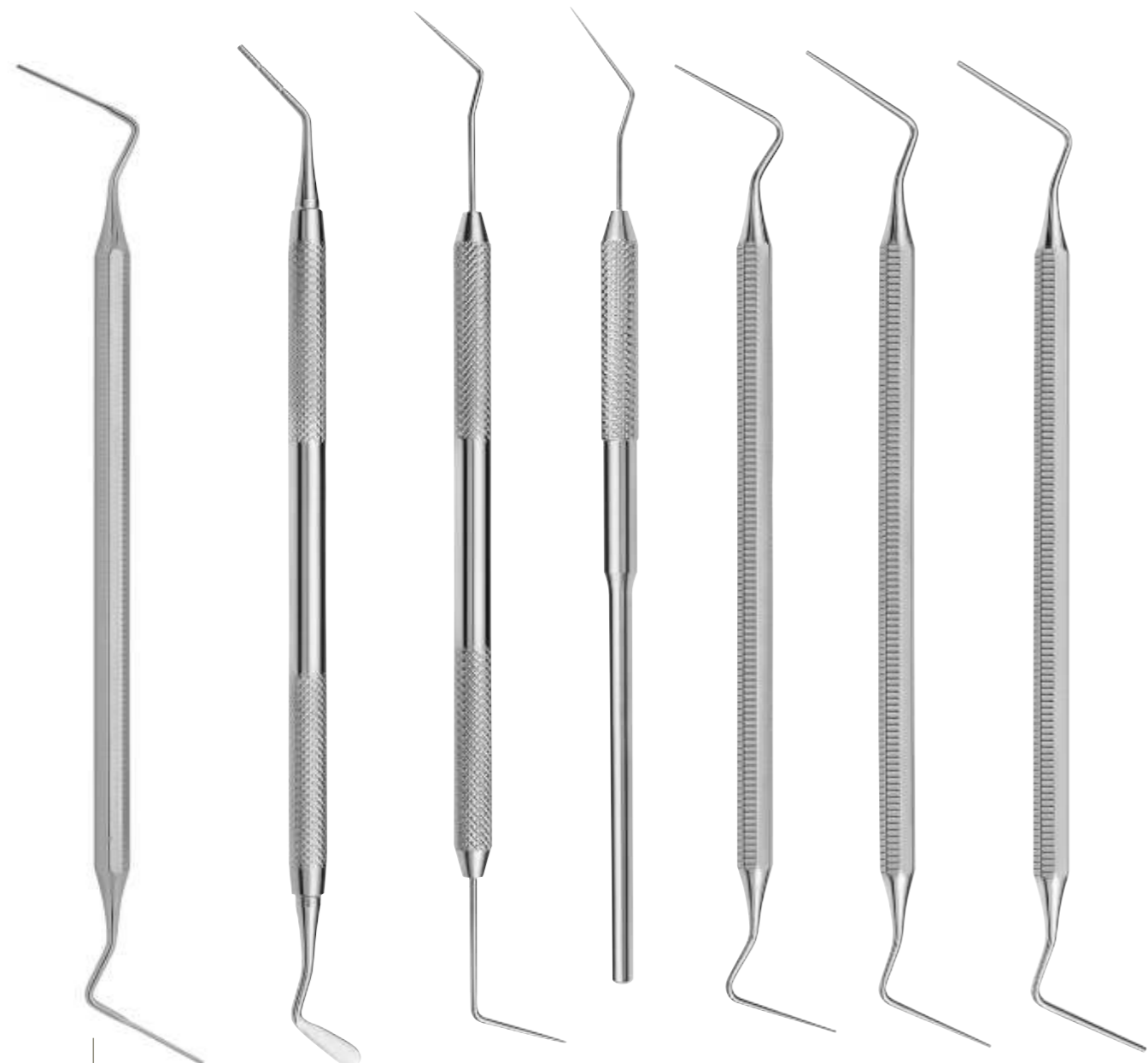

BUCHANAN

Stopfer
0,7mm
118/B1

1,0mm
118/B2

GLICK ENDO

Stopfer/Spatel
118/GL1

DG16

Spreizer
101/16

Spreizer
108/D11T

Stopfer
108/1-3

Stopfer
108/5-7

Stopfer
108/9-11



ENDO BASIS SET

- Endodontie Sonde DG16
- Spiegelgriff mit Meßskala
- Endodontie Pinzette
- Endo-Exkavator #31L
- London College Pinzette mit Schloß
- Endo Exkavator GL2
- Endo Spreizer D11T
- Wurzelkanalstopfer 1-3
- Wurzelkanalstopfer 5-7
- Wurzelkanalstopfer 9-11
- Stieglitz Wurzelsplitterzange
- Dean Zahnfleissschere 17cm gezahnt
- Wasch Tray mit Silikoneinsätzen
288 x 184 x 25mm

PARO CHIRURGIE SET

- Skalpellgriff 13cm für Miniklingen
- Saugkanüle 3mm / 18cm
- Goldman-Fox Raspatorium GF14
- Gillies chirurgische Pinzette 15cm
- Mikroschere 15cm gebogen
- Castroviejo Nadelhalter 14cm TC gerade
- Williams Paro-Sonde
- Gracey Kürette 5-6, lingual - bukkal
- Gracey Kürette 7-8, lingual - bukkal
- Gracey Kürette 11-12, mesial
- Gracey Kürette 13-14, distal
- Universal Scaler 204S
- Sonde e.e. Fig. 23
- Wasch Tray mit Silikoneinsätzen
288 x 187 x 25mm





PARO CLASSIC SET

Gracey Kürette 5-6, lingual - bukkal
Gracey Kürette 7-8, lingual - bukkal
Gracey Kürette 11-12, mesial
Gracey Kürette 13-14, distal
Spiegelgriff
Universal Scaler 204SD
Universal Scaler H6-H7
Meriam Zahnpinzette
Parosonde CP15
Wasch Tray mit Silikoneinsätzen 184 x 150 x 25mm

NEU COLORident KÜRETTEN

Parodontalküretten und Scaler mit Farbmärkierungsring aus Keramik für eine bessere Identifikation, biokompatibel (Griff 10mm)



COLORident GRACEY 1-2
lingual / buccal
404/1-2-ED ☉



COLORident GRACEY 5-6
lingual / buccal
404/5-6-ED ☉



COLORident GRACEY 11-12
mesial
404/11-12-ED ☉



COLORident GRACEY 13-14
distal
404/13-14-ED ☉



COLORident GRACEY 15-16
mesial
404/15-16-ED ☉



COLORident GRACEY 1-2M
DEEP SCALE
lingual / buccal
404/1-2MED



COLORident GRACEY 5-6M
DEEP SCALE
lingual / buccal
404/5-6MED



COLORident GRACEY 7-8M
DEEP SCALE
lingual / buccal
404/7-8MED



COLORident GRACEY 11-12M
DEEP SCALE
lingual / buccal
404/11-12MED



COLORident GRACEY 13-14M
DEEP SCALE
lingual / buccal
404/13-14MED

SCALER



COLORident M23
universal
404/M23-ED



COLORident Scaler 204SD
universal
404/204SD-ED

GRACEY KÜRETTEN / KLASSIKER

ED = mit
ERGODESIGN-
Griff

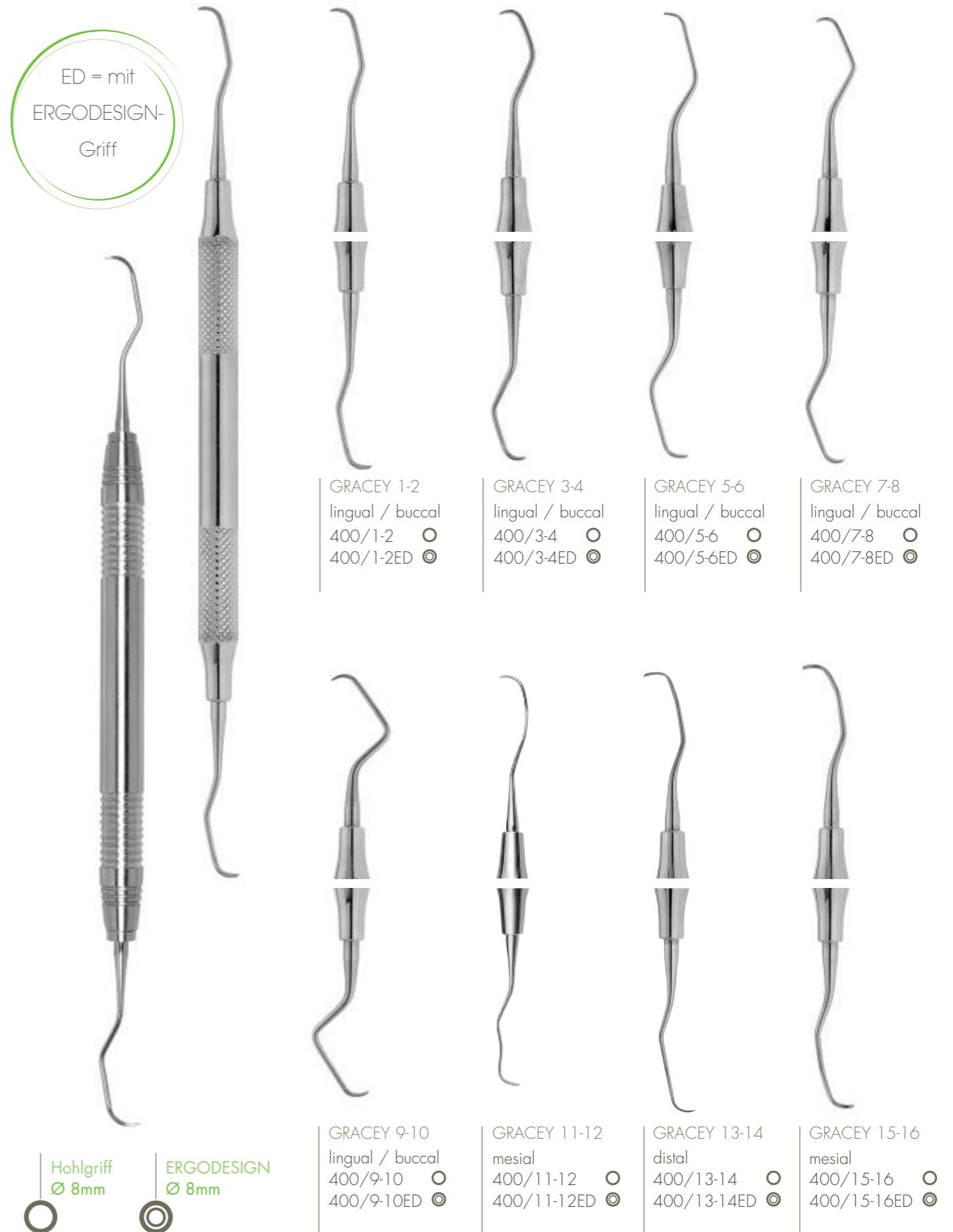

Hohlgriff
Ø 8mm

ERGODESIGN
Ø 8mm

GRIFFVARIANTEN

GRACEY 1-2
lingual / buccal
400/1-2

GRACEY 3-4
lingual / buccal
400/3-4

GRACEY 5-6
lingual / buccal
400/5-6

GRACEY 7-8
lingual / buccal
400/7-8

GRACEY 9-10
lingual / buccal
400/9-10

GRACEY 11-12
mesial
400/11-12

GRACEY 13-14
distal
400/13-14

GRACEY 15-16
mesial
400/15-16

GRACEY KÜRETTEN MINI

DEEP SCALE GRACEYS

NEU: LEIBINGER Deep Scale Graceys sind besonders für den Einsatz in tiefen, engen Taschen und für die Wurzelglättung geeignet. Im Vergleich zu den Standard Graceys ist ihr 1er Schaft 3mm länger und gleichzeitig ist das Arbeitsende um 50% verkürzt.



GRACEY 1-2M
lingual / buccal
400/1-2MED ●

ED = mit
ERGODESIGN-
Griff

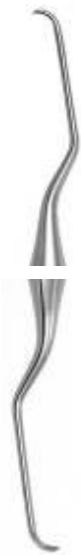

GRACEY 5-6M
lingual / buccal
400/5-6MED ●



GRACEY 7-8M
lingual / buccal
400/7-8MED ●



GRACEY 11-12M
lingual / buccal
400/11-12MED ●



GRACEY 13-14M
lingual / buccal
400/13-14MED ●

SCALER

ED = mit
ERGODESIGN-
Griff



HYGIENIST H6-H7
Universal-Scaler
401/H6-H7 ○
401/H6-H7-ED ●

TOWNER U15-30
401/U15-30 ○

H5-33
401/H5-33 ○
401/H5-33-ED ●

CI 2-3
401/CI03 ○

CK 6
401/CK6 ○
401/CK6-ED ●

TAYLOR 2-3
401/T2-3 ○

Hohlgriff
Ø 8mm ○
ERGODESIGN
Ø 8mm ●

GRIFFVARIANTEN

UNIVERSAL SCALER



204
401/204-ED ●



204 S
401/204S ○
401/204S-ED ●



204 SD
401/204SD ○
401/204SD-ED ●

Spezieller
superharter Edel-
stahl, perfekter Schliff
für langanhaltende
Schärfe



COLUMBIA 2RL
401/2RL ○
401/2RL-ED ●



COLUMBIA 4RL
401/4RL ○
401/4RL-ED ●



COLUMBIA 13-14
401/C13-14 C
401/C13-14-ED ●

Hohlgriff
Ø 8mm ○
ERGODESIGN
Ø 8mm ●
GRIFFVARIANTEN

UNIVERSALKÜRETTEN / DOPPELSEITIG



LANGER 1-2
401/L1-2 ○
401/L1-2-ED ●

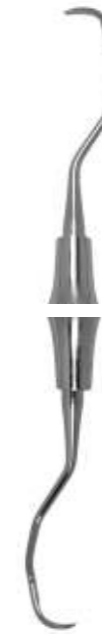

LANGER 3-4
401/L3-4 ○
401/L3-4-ED ●



LANGER 5-6
401/L5-6 ○
401/L5-6-ED ●

ED = mit
ERGODESIGN-
Griff



Hohlgriff
Ø 8mm ○
ERGODESIGN
Ø 8mm ●
GRIFFVARIANTEN



M23
401/M23 ○
401/M23-ED ●



MCCALL 13-14
401/13-14 ○



MCCALL 13S-14S
401/13S-14S ○



MCCALL 17S-18S
401/17S-18S ○

NEU

SHARPcut – SCALER

- Spezielle Hartsoffbeschichtung
- Lang anhaltende Schärfe
- Weniger Verschleiß



Universal-Scaler H6-H7

401/H6-H7-ED-TIN ©



Universal-Scaler 204SD

401/204SD-ED-TIN ©



Scaler M23

401/M23-ED-TIN ©

SHARPcut-GRACEY MINI



GRACEY 1-2M DEEP SCALE

lingual / buccal
400/1-2M-ED-TIN ©



GRACEY 5-6M DEEP SCALE

lingual / buccal
400/5-6M-ED-TIN ©



GRACEY 7-8M DEEP SCALE

lingual / buccal
400/7-8M-ED-TIN ©



GRACEY 11-12M DEEP SCALE

mesial
400/11-12M-ED-TIN ©



GRACEY 13-14M DEEP SCALE

distal
400/13-14M-ED-TIN ©

SHARPcut – GRACEY

ED = mit ERGODESIGN-Griff



GRACEY 1-2 lingual / buccal

400/1-2ED-TIN ©



GRACEY 3-4 lingual / buccal

400/3-4ED-TIN ©



GRACEY 5-6 lingual / buccal

400/5-6ED-TIN ©



GRACEY 7-8 lingual / buccal

400/7-8ED-TIN ©



GRACEY 9-10 lingual / buccal

400/9-10ED-TIN ©



GRACEY 11-12 mesial

400/11-12ED-TIN ©



GRACEY 13-14 distal

400/13-14ED-TIN ©



GRACEY 15-16 mesial

400/15-16ED-TIN ©

GINGIVEXTOMIE-MESSER



GOLDMAN-FOX 7
401/KGF7



GOLDMAN-FOX 8
401/KGF8



GOLDMAN-FOX 9
401/KGF9

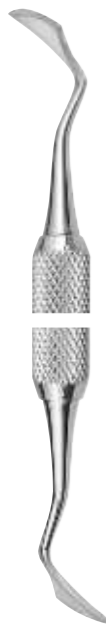

KIRKLAND 15/16
401/K1



ORBAN 1-2
401/KO12



RHODES BACK-ACTION
401/RBA



OCHSENBEIN
401/O4

PARO-FEILEN



HIRSCHFELD 3-7
401/H3-7



HIRSCHFELD 5-11
401/H5-11



SUGARMAN 1S-2S
401/FS12

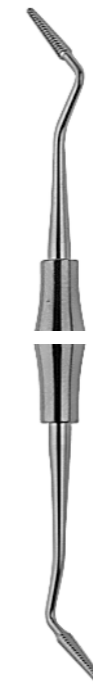

SUGARMAN 3S-4S
401/FS34



SCHLUGER 9-10S
401/FS910

TUNNELIER-INSTRUMENTE



Die Tunnelierinstrumente von Otto Leibinger Dental sind gefertigt für den Einsatz in der Mikrochirurgie zur Präparation von Spalt- und Vollappen für spätere Kammaufbauten sowie zum Aufbau der Gingiva im Falle von Rezessionen. Die fein gearbeiteten Arbeitsenden erlauben eine präzise Eröffnung der Gingiva und somit können große Aufklappungen vermieden werden.

335/T1

335/T2

RASPATORIEN



MOLT 9
335/M9 ○
335/M9-ED ●



GLICKMANN 24GSP
335/24GSP ○
335/24GSP-ED ●



BUSER
335/B1 ○
335/B1-ED ●



GOLDMAN FOX 14
335/GF14 ○
335/GF14-ED ●



MOLT 10
335/M10-ED ●



PRICHARD PR3S
335/PR3S ○



GRIFFVARIANTEN

TITAN-KÜRETTEN

ERGODESIGN Titan Küretten mit federleichtem Griff und Arbeitsenden aus Titan, ideal für die Reinigung von Implantaten. Durch die Verwendung von Titan für die Spitzen wird eine Beschädigung der Implantatoberfläche vermieden. Die L-light Titan Küretten sind in 7 verschiedenen Ausführungen erhältlich.

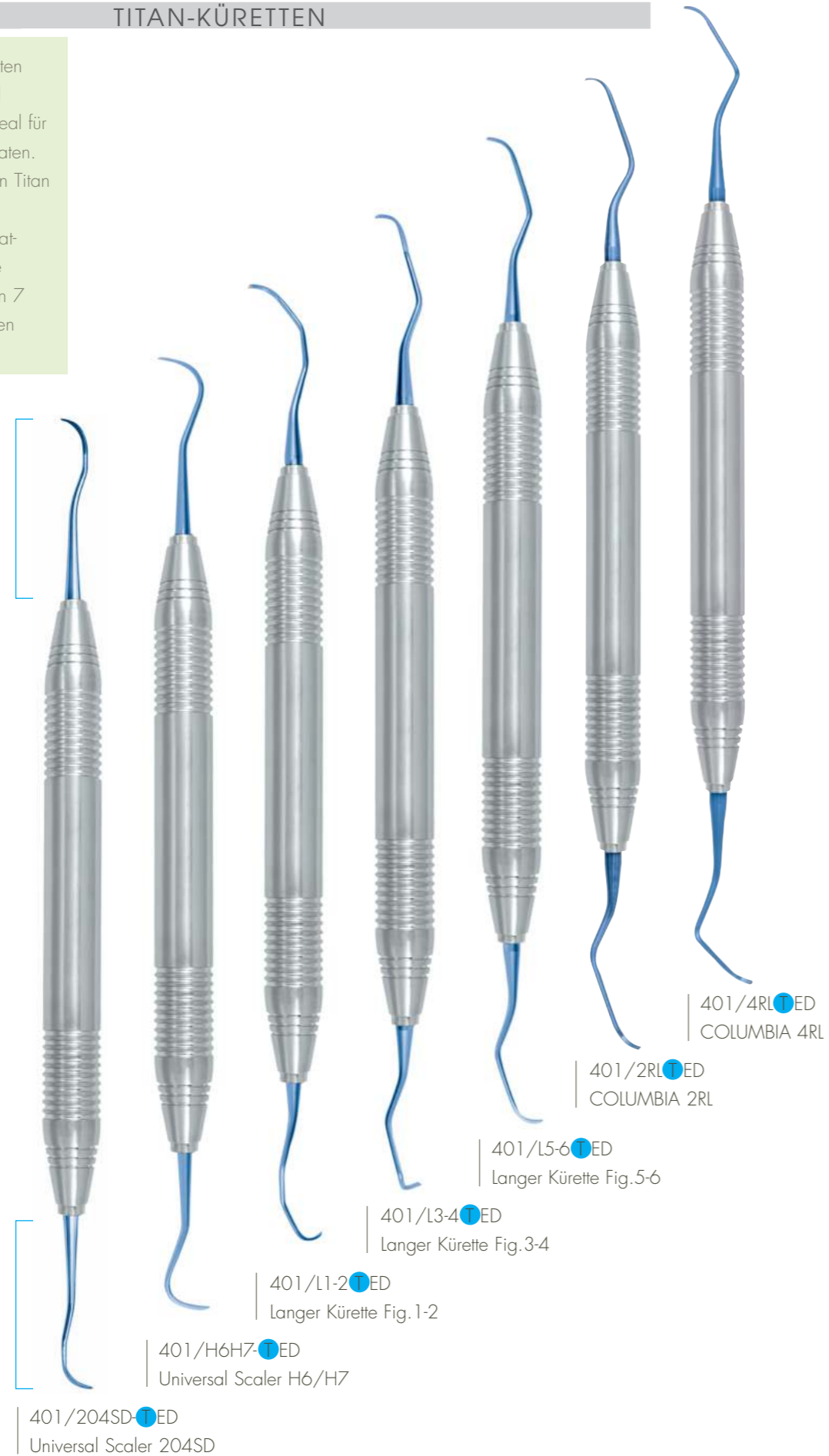

OTTO LEIBINGER ZAHNZANGEN

BEISPIELE:

- FEINE GRAZILE FORM
- HAFTPROFIL FÜR SICHEREN HALT
- GLEICHMÄSSIGER, LEICHTER GANG
- STANDARD-GRIFF VOLLKARIERT
- ERGODESIGN-GRIFF GLATT ZUR EINFACHEN REINIGUNG

Ausgewählte Zangen erhalten Sie auch in der PREMIUM-Qualität. Diese zeichnet sich durch besonders hochwertige Verarbeitung aus.

OPTIMAL

NEU ERGODESIGN

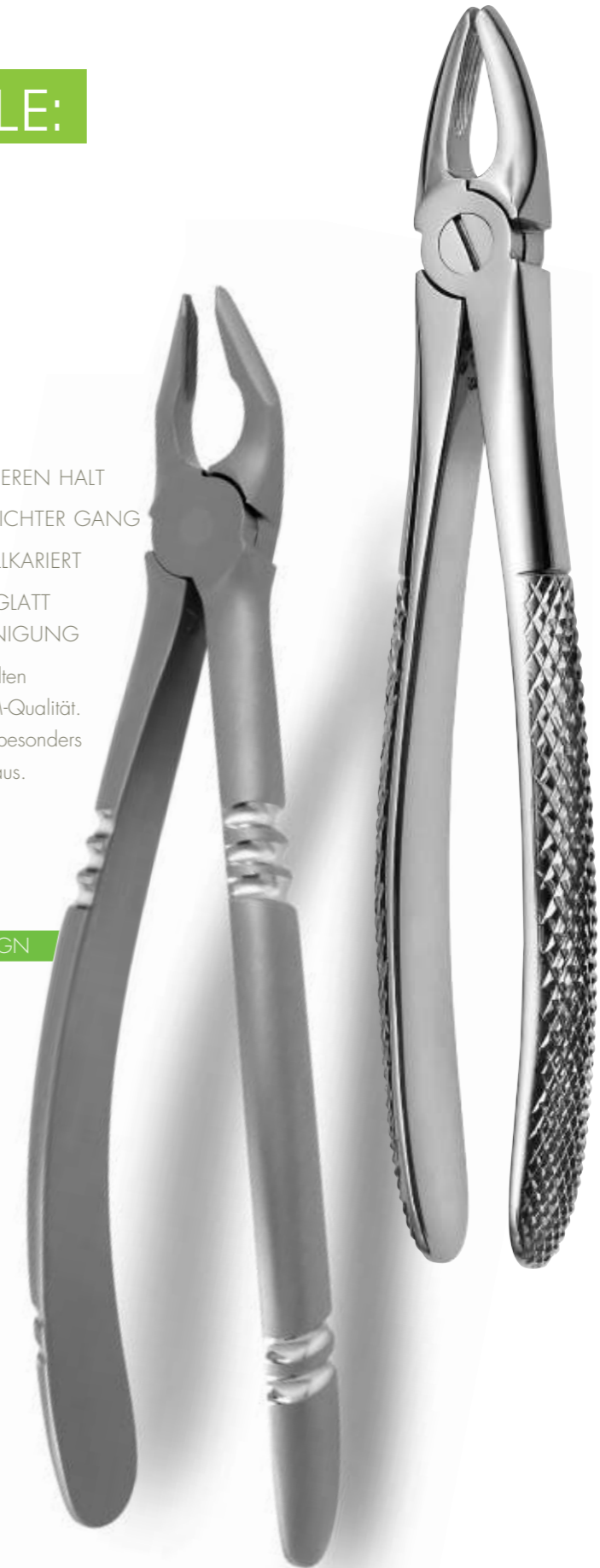

ZAHNZANGEN ENGLISCHE FORM

ZAHNZANGEN ENGLISCHE FORM



P600/...
600/...



FIG.1

obere Schneide- und Eckzähne, breit

P600/1 PREMIUM
600/1



FIG.2

obere Schneide- und Eckzähne
P600/2 PREMIUM
600/2

604/...

NEU

604/2 ERGODESIGN



FIG.7

obere Prämolaren

P600/7 PREMIUM
600/7

NEU

604/7 ERGODESIGN



FIG.17

obere Molaren, rechts
P600/17 PREMIUM
600/17

NEU

604/17 ERGODESIGN



FIG.18

obere Molaren, links
P600/18 PREMIUM
600/18

NEU

604/18 ERGODESIGN



FIG.89

obere Molaren, rechts, tiefgreifend
P600/89 PREMIUM
600/89



FIG.90

obere Molaren, links, tiefgreifend
P600/90 PREMIUM
600/90



FIG.67

obere Weisheitszähne, schmal

600/67

NEU

604/67 ERGODESIGN



FIG.67A

obere Weisheitszähne, breit
P600/67A PREMIUM
600/67A

ZAHNZANGEN ENGLISCHE FORM



FIG.29
obere Frontzahnwurzeln
P600/29 PREMIUM
600/29
NEU 604/29 ERGODESIGN



FIG.30
obere Wurzeln
P600/30 PREMIUM
600/30



FIG.51
obere Wurzeln, kurzes,
schmales Maul
P600/51 PREMIUM
600/51



FIG.76
obere
Wurzeln
600/76



obere
Wurzeln,
schmal
600/76N



FIG.51A
obere Wurzeln,
schmales Maul
P600/51A PREMIUM
600/51A
NEU 604/51A ERGODESIGN



P600/...
600/...
604/... **ERGODESIGN**



FIG.4
untere Schneidezähne
P600/4 PREMIUM
600/4
NEU 604/4 ERGODESIGN



FIG.13
untere Eckzähne und Prämolaren
P600/13 PREMIUM
600/13
NEU 604/13 ERGODESIGN



FIG.22
untere Molaren, beide Seiten
P600/22 PREMIUM
600/22
NEU 604/22 ERGODESIGN



FIG.73
untere Molaren
P600/73 PREMIUM
600/73



FIG.75
untere Eckzähne und Prämolaren
P600/75 PREMIUM
600/75



FIG.33
untere Wurzeln
P600/33 PREMIUM
600/33
NEU 604/33 ERGODESIGN



FIG.33A
untere Wurzeln, mit schmalen Ma
P600/33A PREMIUM
600/33A



FIG. 86A

untere Molaren, tiefgreifend, von lateral
P600/86A PREMIUM
600/86A

NEU 604/86A ERGODESIGN



FIG. 86C

untere Molaren, tiefgreifend,
von lateral
600/86C

SPEZIAL



FIG. 79

untere Weisheitszähne
P600/79 PREMIUM
600/79

NEU 604/79 ERGODESIGN



FIG. 79A

untere Weisheitszähne
600/79A

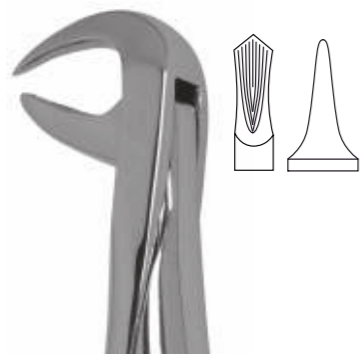

FIG. 99

untere Molaren
600/99

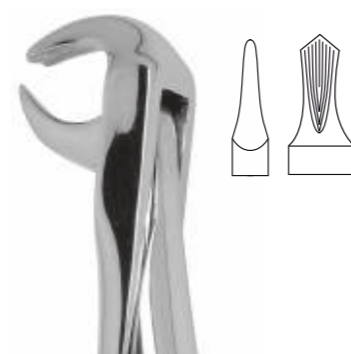

FIG. 99 1/4

untere Molaren
600/99-1-4

SPEZIAL



FIG. 34

obere Schneidezähne und Eckzähne,
Spez.-Maul, tiefgreifend
600/34

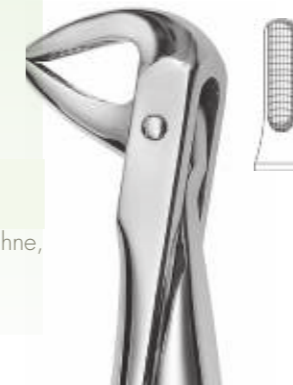

FIG. 74

untere Wurzeln, Maul
P600/74 PREMIUM
600/74

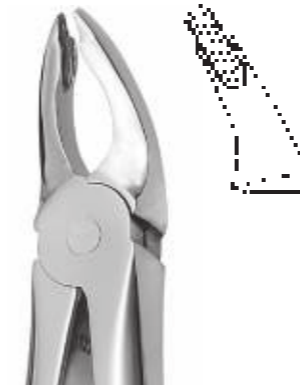

FIG. 35

obere Prämolaren,
Spez.-Maul, tiefgreifend
600/35



FIG. 74N

untere Wurzeln
und engstehende Schneidezähne
P600/74N PREMIUM
600/74N

NEU 604/74N ERGODESIGN



FIG. 36

untere Wurzeln, Spez.-Maul, tief-
greifend
600/36



FIG. 46L

sehr feine untere Wurzeln,
tiefgreifend
P600/46L PREMIUM
600/46L



600/...
604/... ERGODESIGN



FIG. 37
obere Schneidezähne
600/37
NEU 604/37 ERGODESIGN



FIG. 39
obere Molaren, beide Seiten, breit
600/39
NEU 604/39 ERGODESIGN



FIG. 39L
obere Molaren, links
600/39L



FIG. 39R
obere Molaren, rechts
600/39R



FIG. 51S
obere Wurzeln
600/51S
NEU 604/51S ERGODESIGN



FIG. 29S
obere Schneidezähne und Wurzeln,
beide Seiten
600/29S
NEU 604/29S ERGODESIGN



FIG. 13S
untere Schneidezähne und Prämolaren
600/13S
NEU 604/13S ERGODESIGN



FIG. 22S
untere Molaren
600/22S
NEU 604/22S ERGODESIGN

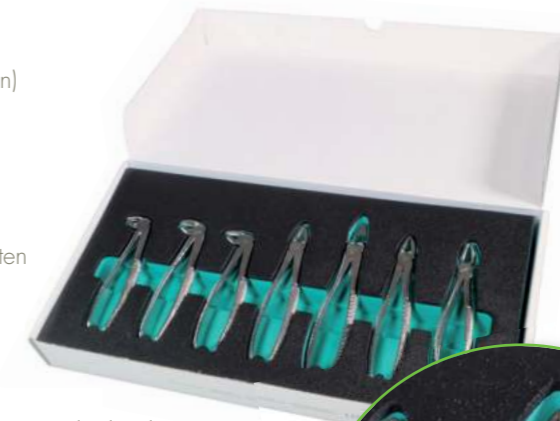

FIG. 33S
untere Wurzeln
600/33S
NEU 604/33S ERGODESIGN

ZAHNZANGEN-SET FÜR KINDER / KURZ

Zahnzangen Set für Kinder (7 Zangen)

- FIG. 37 obere Schneidezähne
- FIG. 39 obere Molaren, beide Seiten
- FIG. 51S obere Wurzeln
- FIG. 29S obere Schneidezähne und Wurzeln, beide Seiten
- FIG. 13S untere Schneidezähne und Prämolaren
- FIG. 22S untere Molaren, beide Seiten
- FIG. 33S untere Wurzeln



600/PEDO-SET

» auch im ERGODESIGN erhältlich

NEU 604/PEDO-SET-ED



ZAHNZANGEN ENGLISCHE FORM / KINDER (KURZ)



FIG.3
obere Molaren
605/3

KLEIN



FIG.137
obere Schneidezähne
605/137



FIG.139
obere Milchmolaren
605/139



FIG.51S
obere Wurzeln
605/51S



FIG.5
untere Schneidezähne
605/5

FÜR KINDER / KURZ



FIG.6
untere Molaren
605/6



FIG.7
untere Wurzeln
605/7

ZAHNZANGEN EXTRAKTIONS-SET (BESTEHEND AUS 10 ZANGEN)

- P600/SET PREMIUM Set
- 600/SET STANDARD Set
- NEU** 604/ED-SET ERGODESIGN Set

- FIG.2 obere Schneide- und Eckzähne
- FIG.7 obere Prämolaren
- FIG.17 obere Molaren, rechts
- FIG.18 obere Molaren, links
- FIG.67A obere Weisheitszähne, breit
- FIG.51A obere Wurzeln, schmal
- FIG.13 untere Eckzähne und Prämolaren
- FIG.22 untere Molaren beide Seiten
- FIG.33 untere Wurzeln
- FIG.79 untere Weisheitszähne



DEEP GRIP ZAHNZANGEN

SPEZIAL

ANATOMISCH
GEFORMTE,
SCHMALE
ARBEITSENDEN



FIG.2
obere Schneide-
und Eckzähne
603/2



FIG.7
obere Prämolaren
603/7

NEU 603/... ERGODESIGN

TIEFGREIFEND



FIG.34
obere Schneidezähne und Eckzähne,
Spez.-Maul
603/34



FIG.35
obere Prämolaren,
Spez.-Maul
603/35



FIG.67
obere Weisheitszähne, schmal
603/67



FIG.79
untere Weisheitszähne
603/79

DEEP GRIP ZAHNZANGEN

SPEZIAL



FIG.13
untere Eckzähne und Prämolaren
603/13



FIG.33
untere Wurzeln
603/33



FIG.36
untere Wurzeln,
Spez.-Maul,
603/36



FIG.74N
untere Wurzeln
und engstehende Schneidezähne
603/74N

WURZELSPPLITTER-ZANGEN



WITZEL
610/1



Wurzelfragmentzange
610/5



ARTHUR
gerade
610/3
gebogen
610/3A

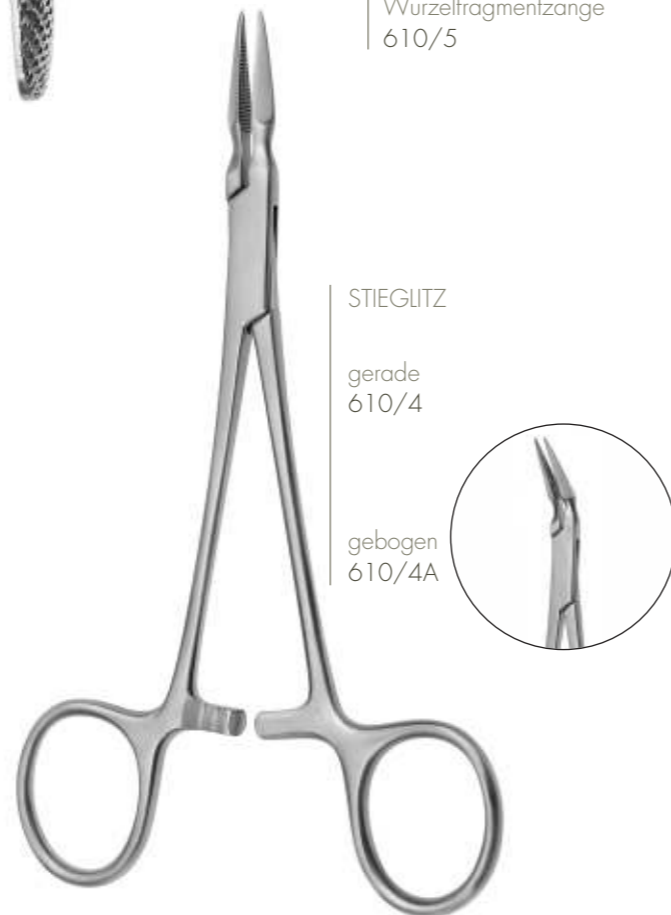

STIEGLITZ
gerade
610/4
gebogen
610/4A

WURZELHEBER



2mm
3mm
4mm
3mm
190/1
190/2
190/3
gerade
190/4



BEIN



190/6
190/7

FLOHR

WURZELHEBER



CRYER
190/13



CRYER
190/14



BARRY
190/B50



BARRY
190/B51



APICAL 1
193/301



APICAL 2
193/302



APICAL 3
193/303

WURZELHEBER



COUPLAND



FIG.1
190/15



FIG.2
190/16



FIG.3
190/17



192/1



192/2



192/3

WARWICK JAMES

WURZELHEBER



HYLIN



4 mm
190/31

3 mm
190/32

190/33

190/34

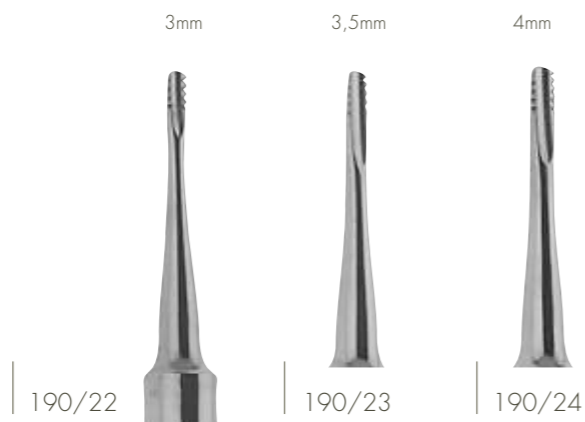

190/22

190/23

190/24

LINDO LEVIAN

WURZELHEBERSPITZEN

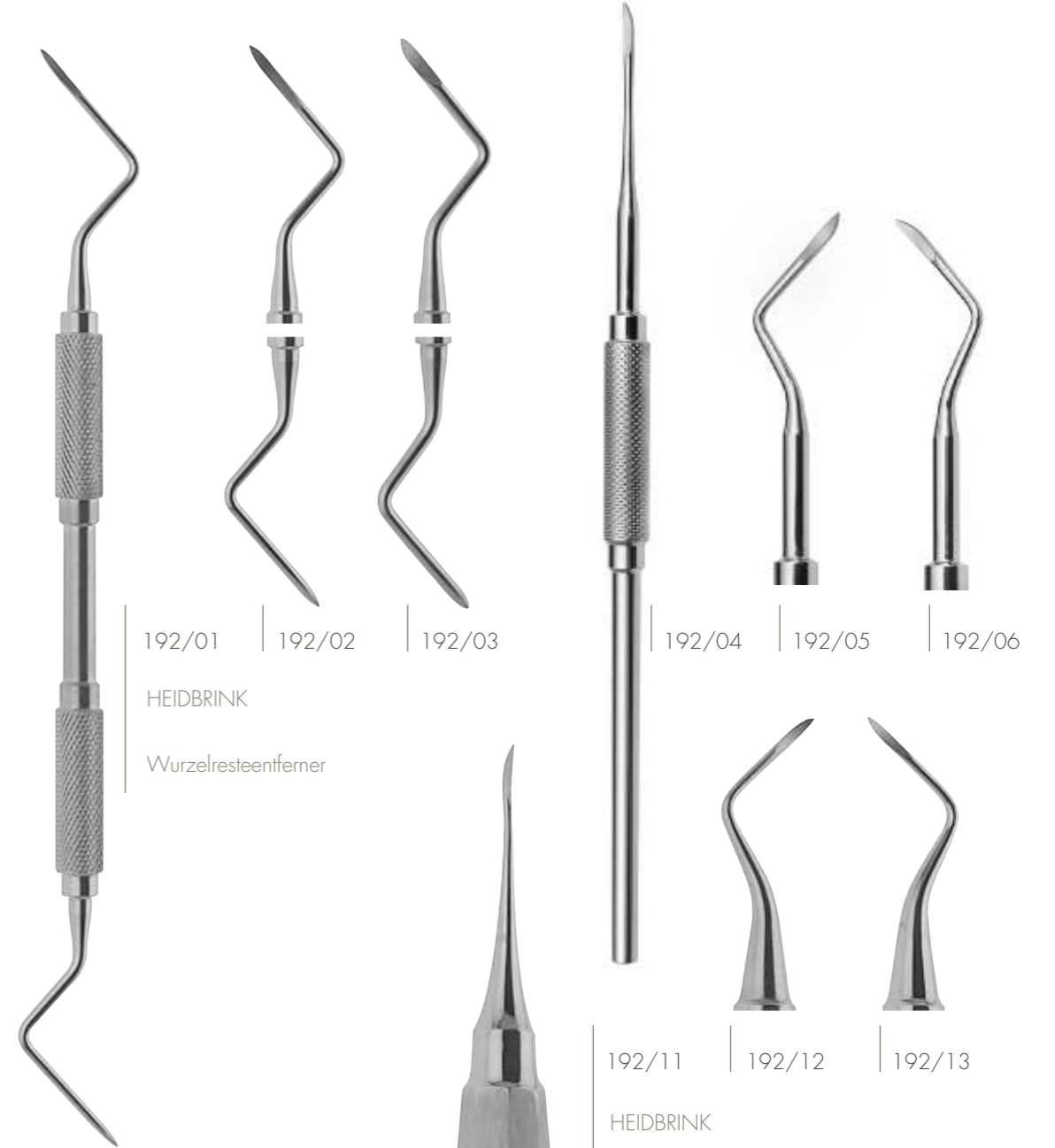

192/01

192/02

192/03

HEIDBRINK

Wurzelrestentferner

192/04

192/05

192/06

192/11

192/12

192/13

HEIDBRINK

Wurzelspitzenheber



LUXATOREN



Mit den LEIBINGER ERGODESIGN Luxatoren können die feinen Fasern, die die Zahnwurzel mit dem Kieferknochen verbinden (Ligamente) durchtrennt und das Zahnfach (Alveole) aufgeweitet werden, so dass der Zahn die Verbindung zum Knochen verliert und leicht entfernt werden kann. Somit erhalten Sie eine schonende Extraktion, ideal für die Vorbereitung einer Implantation.

3 mm	190/L1ST-ED	190/L1C-ED	190/3ST-ED	190/3C-ED
4 mm	190/L2ST-ED	190/L2C-ED	190/4ST-ED	190/4C-ED
4,5 mm			190/45ST-ED	190/45C-ED

LUXATOREN

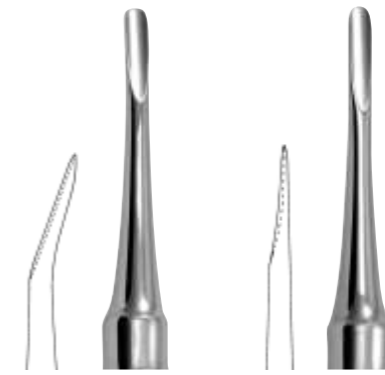

NEU	2,5mm	190/25C	190/25ST
	3 mm	190/3C	190/3ST
	4 mm	190/4C	190/4ST
	5 mm	190/5C	190/5ST

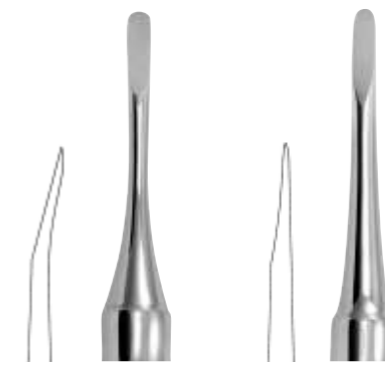

	3 mm	190/3CF	190/3STF
	4 mm	190/4CF	190/4STF
	5 mm	190/5CF	190/5STF

ZYLINDER-AMPULLEN-SPRITZE



MIT PFEILASPIRATION

metrisches Gewinde 1,8ml
370/18M

metrisches Gewinde 2,2ml
370/22M



OHNE ASPIRATION

metrisches Gewinde 1,8ml
371/18M

metrisches Gewinde 2,2ml
371/22M

WUND- UND MUNDHAKEN / ZUNGENSPEL



AUSTIN
353/7



WIEDER
14cm
354/W1

14,5cm
354/W2



FARABEUF

Set mit 2 Stück

125mm
353/8

150mm
353/9



CAWOOD MINNESOTA
354/6



TUFFIER

Zungenspatel biegsam
200mm
354/7



BRUENINGS

Zungenspatel
190mm
354/8

MUNDHAKEN

WUNDHAKEN



BRAANEMARK
 Vestibulum-Haken
 700/2 A=80mm
 für Kinder
 700/2K A=75mm



Vestibulum und
 Wangenabhalter
 700/6 A=80mm



STERNBERG
 Lippenhalter
 14cm
 700/3



MOLT
 12cm
 700/7
 14cm
 700/8

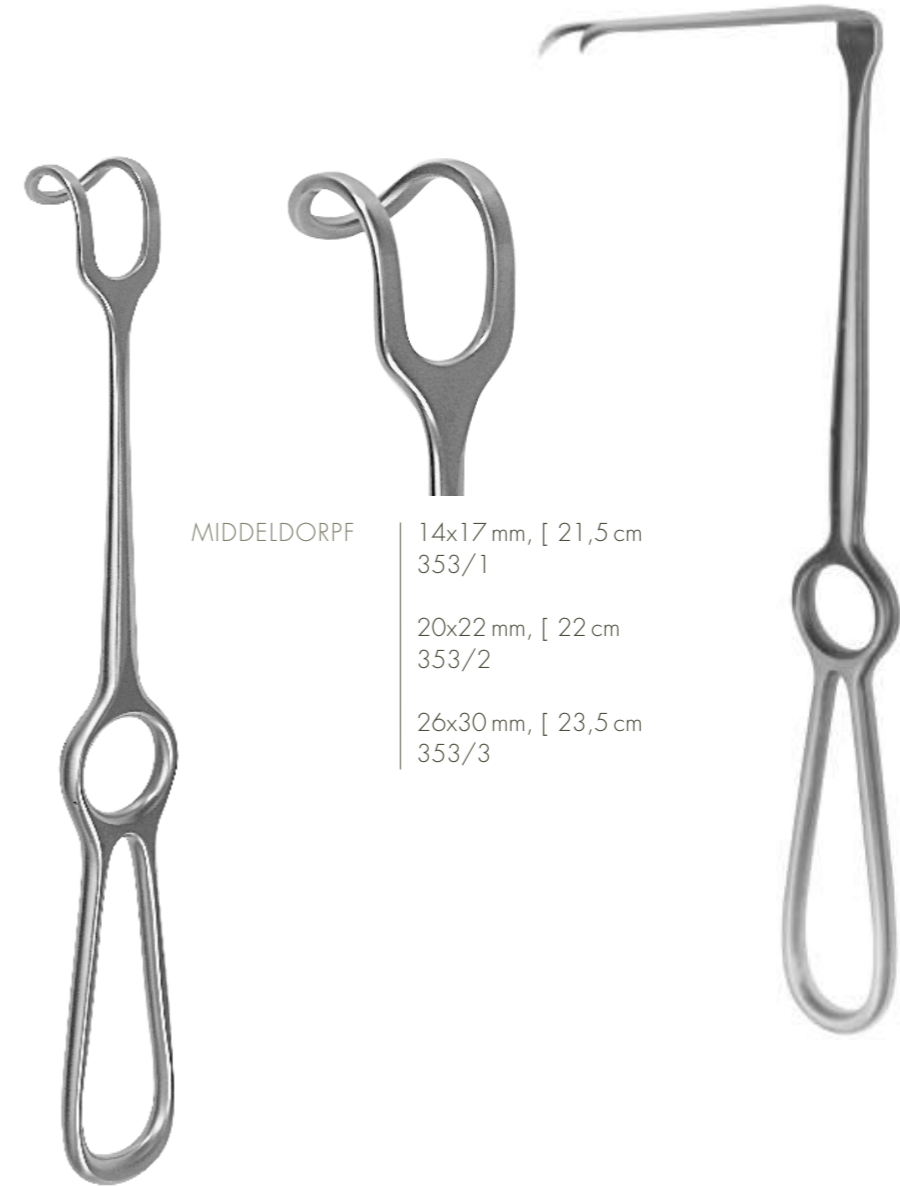

MIDDELDORPF

14x17 mm, [21,5 cm
 353/1
 20x22 mm, [22 cm
 353/2
 26x30 mm, [23,5 cm
 353/3

OBWEGESER

72x11 mm, [22 cm
 353/5

WUNDHAKEN

HAMMER



30x11 mm, [22 cm
355/11

28x14 mm, [22 cm
355/12

30x16 mm, [22 cm
355/13

40x11 mm, [22 cm
355/14

50x11 mm, [22 cm
355/15

KOCHER-LANGENBECK



OBWEGESER

Progeniehaken
8 mm, [175 mm
353/20

10 mm, [175 mm
353/21



BOWDLER HENRY
[19cm
353/12

mit Bleifüllung
Ø 22mm / 140g

[16,5cm
330/1



mit auswechselbaren
Kunststoffbacken
Ø 25mm / 140g

[18cm
330/3



RASPATORIEN

WILLIGER
160x6 mm
335/06



OBWEGESER
[17,5 cm
6 mm
337/71



7 mm
337/72

9 mm
337/73

11 mm
337/74

SELDIN S23
[19,5 cm
335/S23



HOWARTH
[21,5 cm
335/H



WILLIGER
[16,5 cm
337/1



scharf

stumpf

FREER
[18,5 cm
336/5



KNOCHENFEILEN / SCHARFE LÖFFEL

KNOCHENFEILEN

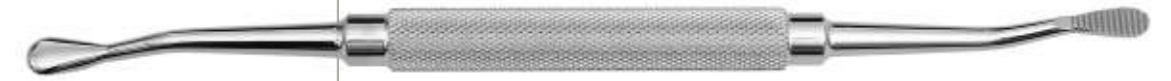

MILLER
338/3



MILLER
338/4



MILLER
338/5



OCHSENBEIN 1
332/41



OCHSENBEIN 2
332/42

SCHARFE LÖFFEL



HEMINGWAY

[18 cm

2,5 mm

130/1

3,0 mm

130/2

3,5 mm

130/3



LUKAS
[18 cm

FIG.1

2,5 mm

336/11

336/11-ED

FIG.2

3,0 mm

336/22

336/22-ED

GRIFFVARIANTEN

Achtkant-Griff
Ø 5,5 mm

ERGODESIGN
Ø 8 mm

SKALPELLGRIFFE



[16 cm
185/5

185/5ED

[16 cm
185/6

185/6ED

Skalpellklingen
auf Anfrage
erhältlich



Mikro Skalpellklingenhalter
für Mini-Klingen
[13 cm
185/8MK



FIG. 3
[12,5cm
185/3

SAUGKANÜLE / PINZETTEN

SAUGKANÜLE



[19 cm

Ø 1,5 mm
195/1

Ø 3,0 mm
195/2

Ø 5,0 mm
195/3

mit Einkerbung

[14 cm

Ø 1,5 mm
195/4

Ø 3,0 mm
195/05

Ø 5,0 mm
195/6

[19 cm

Ø 1,5 mm
195/4

Ø 3,0 mm
195/5

Ø 5,0 mm
195/6

ANATOMISCHE PINZETTEN

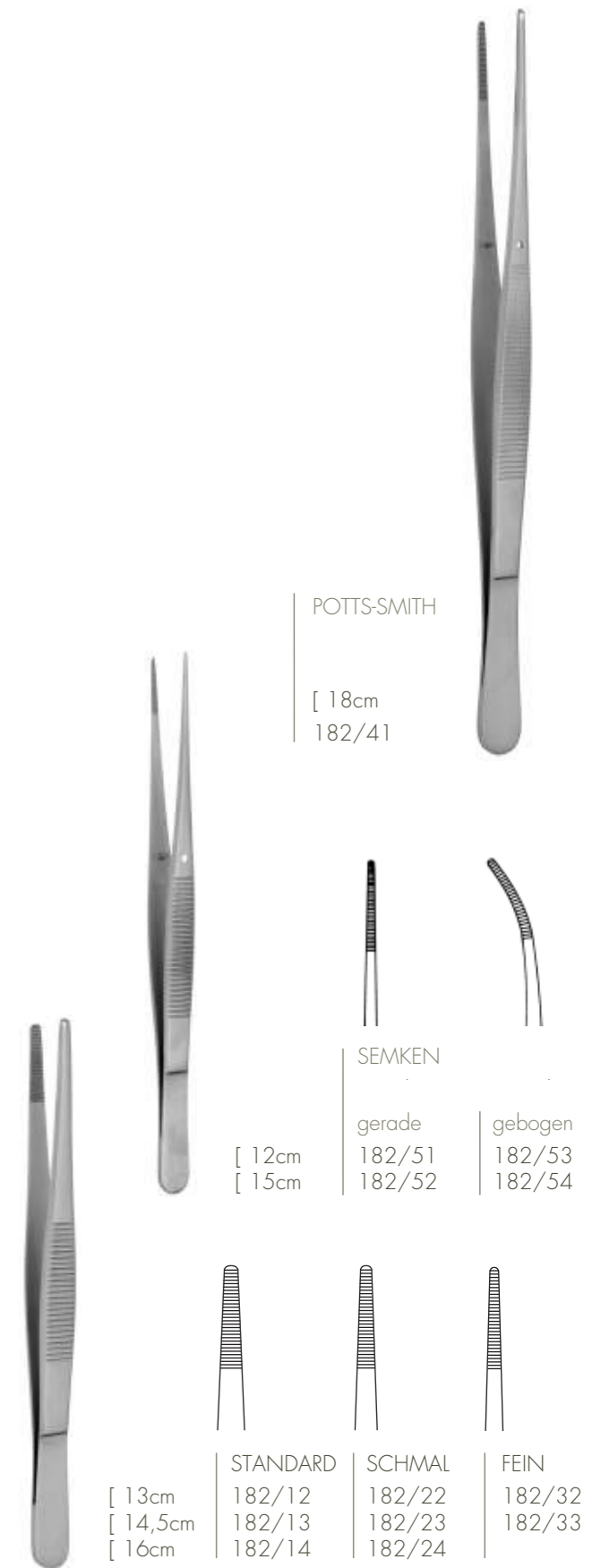

POTTS-SMITH

[18cm
182/41

SEMKEN

gerade

182/51

182/52

gebogen

182/53

182/54

[12cm
[15cm



STANDARD

182/12

182/13

182/14

SCHMAL

182/22

182/23

182/24

FEIN

182/32

182/33

[13cm

[14,5cm

[16cm

ANATOMISCHE PINZETTEN



ADSON
[12cm 182/61
[15cm 182/62



MICRO ADSON
182/63



McINDOE
[15cm
182/1

CHIRURGISCHE PINZETTEN



STANDARD
[13cm 183/12
[14,5cm 183/13
[16cm 183/14



SCHMAL
183/22
183/23
183/24



FEIN
183/32
183/33



SEMKEN
gerade
[12cm 183/51
[15cm 183/52



gebogen
183/53
183/54



POTTS-SMITH
[18cm
183/41



CHIRURGISCHE PINZETTEN

SCHEREN - SUPERCUT

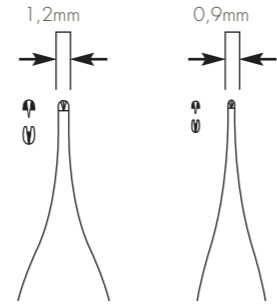

ADSON
183/61
183/62

MICRO ADSON
183/63
183/64

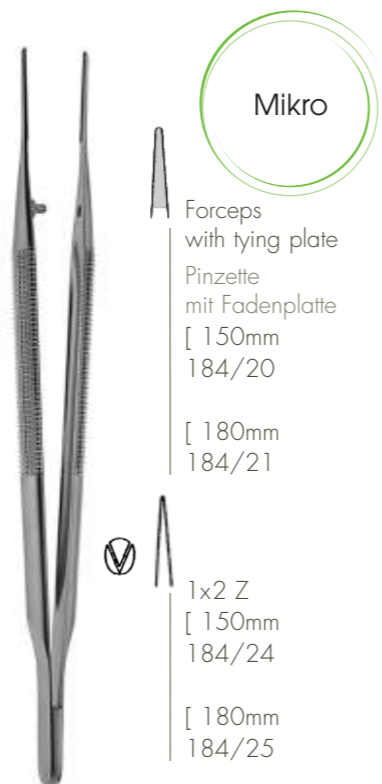

CHIRURGIE SCHEREN

CHIRURGIE SCHEREN



fein
[14,5 cm

gerade
217/4



gebogen
218/4



WAGNER
[12 cm

gerade
230/1



gebogen
230/2



LOCKLIN
[16 cm

gezahnt
236/2



DEAN
[17 cm

gezahnt
242/3



JOSEPH
[14,5 cm

gerade
235/3



gebogen
235/4



SPENCER
[9 cm
250/20

[10,5 cm
250/21

[12,5 cm
250/22



Mikro

Schere
gerade
[150mm
251/31

[180mm
251/32

gebogen
[150mm
251/33

[180mm
251/34



METZENBAUM

gerade
[14 cm
229/1

[18 cm
229/3

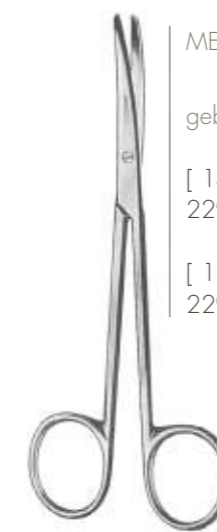

METZENBAUM

gebogen
[14 cm
229/2

[18 cm
229/4



BEEBEE

gerade
[10,5 cm
210/1



BEEBEE

gebogen
[10,5 cm
210/2



UNIVERSAL
[12cm

Folien-/Draht- & Bleischere
250/5
250/5

NADELHALTER MIT TC-EINSÄTZEN

INSTRUMENTE MIT TC-EINSÄTZEN

Für unsere Nadelhalter werden TC (Wolframkarbid) Einsätze verwendet, die bei der Härtung einen besonderen Härtegrad (HRC) erzielen, so dass eine aussergewöhnliche Lebensdauer der Instrumente garantiert ist. Im Vergleich zu normalen Edelstahlinstrumenten sind Nadelhalter mit TC-Einsätzen empfindlicher gegenüber Chemikalien und erfordern aus diesem Grund eine besondere Pflege.

Eine nachträgliche Neubelegung ist möglich!

BARRAQUER
[18 cm
gerade
174/66 TC



5/0 - 7/0





6/0 - 8/0

MICRO-CASTROVIEJO
[14 cm
gerade
174/59 TC





gebogen
174/60 TC

CASTROVIEJO
[14 cm
gerade
174/55 TC



curved
174/57 TC



5/0 - 7/0

NADELHALTER MIT TC-EINSÄTZEN

MATHIEU
[14 cm
175/3
175/3 TC

3/0 - 4/0
ohne TC

CRILE WOOD
[15 cm
175/61
175/61 TC



3/0 - 4/0

[18 cm
175/62
175/62 TC

OLSEN HEGAR
[14 cm
175/6
175/6 TC



3/0 - 4/0

MAYO HEGAR
[14 cm
175/71
175/71 TC



3/0 - 4/0

[16 cm
175/72
175/72 TC

[18 cm
175/73
175/73 TC

NADELHALTER MIT TC-EINSÄTZEN

CHIRURGIE BASIS-SET



CHIRURGIE BASIS SET

- Spiegelgriff
- London College Pinzette 15cm
- Skalpgriff gerade
- Prichard Raspatorium
- Adson Pinzette 12cm 1x2Z
- Semken chir. Pinzette 15cm 1x2Z
- Goldman-Fox Schere gebogen 13cm / SC
- TC Crile-Wood Nadel Halter 15cm
- Iris Zahnfleischschere gebogen 11,5cm SC
- Cawood-Minnesota Wangenhalter
- Lucas Kürette klein
- Halstead Mosquito Arterienklemme 14cm
- Wasch Tray mit Silikoneinsätzen
288 x 184 x 25mm

ARTERIENKLEMMEN



HALSTEAD MOSQUITO

gerade
[12 cm
290/1
291/11 ☺

[14 cm
290/14
291/14 ☺

gebogen
[12 cm
290/2
291/21 ☺

[14 cm
290/15
291/24 ☺



☺
1:2
Zähne



MICRO-MOSQUITO

gerade
[12 cm
290/11
291/16 ☺

gebogen
[12 cm
290/12
291/26 ☺



ARTERIEN- UND TUCHKLEMMEN



KELLY

gerade
[14 cm
290/31

gebogen
[14 cm
290/32



PROVIDENCE-HOSPITAL

gerade
[14 cm
290/35

gebogen
[14 cm
290/36



GROSS-MAIER

Kornzange
[18cm gerade
296/11



BACKHAUS

Tuchklemme
[9cm
298/31

[11cm
298/32

HOHLMEISSELZANGEN

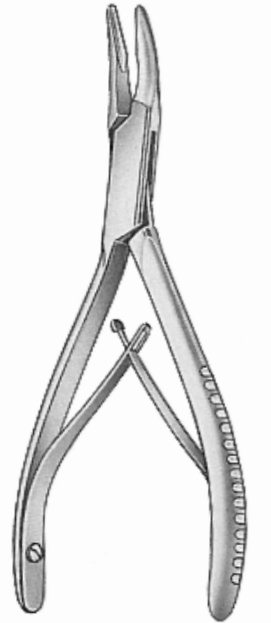

MINI FRIEDMANN
[12 cm
136/01



FRIEDMANN
[14 cm
136/0

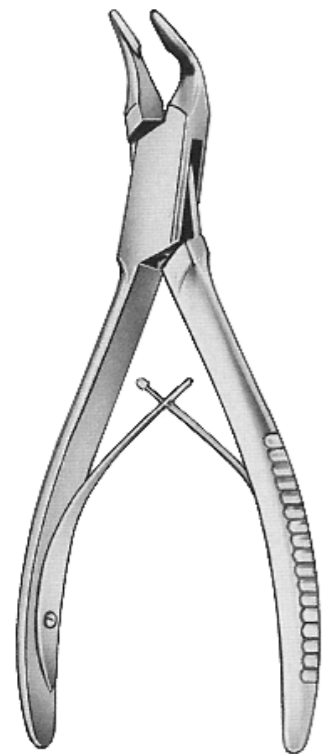

BLUMENTHAL
[15,5 cm

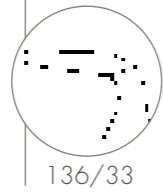
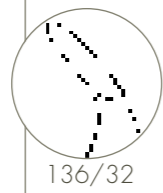
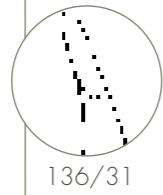

LUER
[15 cm

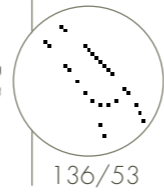
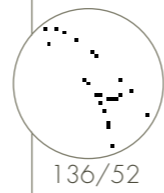
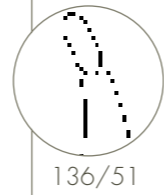

HOHLMEISSELZANGEN



HARTMANN
[18 cm
136/4



BÖHLER
[15 cm
137/1

IMPLANTOLOGIE-INSTRUMENTE

KRONENABNEHME-ZANGE



Nadelhalter
gerade
[150mm
174/80 **T**

[180mm
174/81 **T**

gebogen
[150mm
174/82 **T**

[180mm
174/83 **T**



Schere
gerade
[150mm
251/31 **T**

[180mm
251/32 **T**

gebogen
[150mm
251/33 **T**

[180mm
251/34 **T**



Pinzette
mit Fadenplatte
[150mm
184/20 **T**

1x2 Z
[150mm
184/24 **T**

Mit auswechselbaren Kunststoffbacken zum schonenden Greifen/ Abnehmen von Kronen und Brücken.

Die Zangen können sowohl für Unter- als auch Oberkiefer verwendet werden.

Durch die elastischen Kunststoffbacken werden Beschädigungen, insbesondere an Keramikronen vermieden.

Die Einsätze sind ebenfalls sterilisierbar.

Die Kunststoffbacken können im 2-N-Satz nachbestellt werden!



mit Stellschraube (verhindert Abrutschen und Quetschen der Krone)